

Owner's Manual

MP-8
MP-9
Projectors





Before operating the projector for the first time, read section 4.1 *Warnings and Guidelines*.

NOTICE

The projector generates and may radiate radio frequency energy. If not installed and used in accordance with this manual, it may cause interference with radio communications.

The projector is tested to and complies with the limits for a Class A computing device pursuant to subpart J of part 15 of FCC rules, which are designed to provide reasonable protection against interference in a commercial environment. When the projector is operated in a residential area it may cause radio interference. In such a case the user will be required, at his/her expense, to take measures required to correct the interference.

The projector is tested to and complies with the limits for a Class A digital apparatus pursuant to the Canadian Department of Communications radio interference regulations. The regulations are designed to provide reasonable protection against such interference from devices operated in a commercial environment.

Cet appareil à affichage numérique a été contrôlé. Il est conforme aux limites des règlements de la Classe A d'appareils à affichage numérique établis par le Ministère des Communications du Canada en ce qui concerne les interférences radio. Ces règlements ont été mis en place pour assurer une protection raisonnable contre les interférences produits par des appareils utilisés dans un environnement commercial.

CAUTION

Only use attachments or accessories recommended by Madrigal Imaging. Use of others may result in the risk of fire, shock or personal injury.

Typographical Conventions

Please note the following typographical conventions used throughout this manual.



- Warnings that relate to user safety are highlighted in **BOLD** print.
- First and second level subsection titles are located in the left margin of each page. Third level titles are located within the body text and are in ***bold italic*** print.
- The pointing hand symbol  emphasizes important information within a subsection or paragraph.
- Key symbols (**POWER**, **SOURCE**, **S**, etc.), when located in the left margin, indicate initial keystrokes required for the function being described in the adjoining text.
- Special notes and comments appear in *italics*. Important terms within a paragraph appear in *italics*.
- The ACON symbol  indicates that the associated subsection applies only to projectors which include the ACON automatic convergence feature. ACON is a registered trademark of Electrohome Limited.

Table of Contents

	Section	Contents	Page
1	Introduction	1.1 The Projector _____	1.1
		1.2 Purchaser's Record and Servicing _____	1.2
2	Installation & Setup	2.1 Quick Setup _____	2.1
		2.2 Installation Considerations _____	2.2
		2.3 Hardware Setup _____	2.8
		2.4 Mounting _____	2.12
		2.5 Power Connection _____	2.15
		2.6 Source Connections _____	2.15
		2.7 Serial Port Connections _____	2.16
		2.8 Optical Alignment _____	2.17
		2.9 Source Setup _____	2.26
		2.10 Memory Setup _____	2.29
		2.11 ACON Setup _____	2.35
3	Operation	3.1 Overview _____	3.1
		3.2 Projector Basics _____	3.1
		3.3 Source Selection _____	3.10
		3.4 Setup Memories _____	3.14
		3.5 Display Adjustments _____	3.16
		3.6 Convergence Registration _____	3.27
		3.7 Utility Features _____	3.34
		3.8 Multi-projector Functions _____	3.51
4	Maintenance	4.1 Warnings and Guidelines _____	4.1
		4.2 Cleaning _____	4.3
		4.3 Troubleshooting _____	4.3
5	Specifications	5.1 Specifications _____	5.1
6	Appendices	A Glossary _____	A.1
		B Menu Tree _____	B.1
		C ASR/ASI Logic Diagrams _____	C.1
		D Communication Cables _____	D.1
		E Keypad Reference _____	E.1
		F Throw Distance Tables _____	F.1
		G Lenses _____	G.1
		H Interfaces _____	H.1

NOTE: Due to constant research, the information in this manual is subject to change without notice.

Introduction

1.1 The Projector

The Madrigal Imaging *MP-8* and *MP-9* projectors are ultra high resolution graphics projectors compatible with virtually all input sources. Their superior performance and high quality projected images place them well above other projection systems in their class. Features include:

- color-corrected lens systems to conform to HDTV standards
- automatic lock to inputs between 14 kHz and 152 kHz
- liquid coupled (MP-9) or air coupled (MP-8) lens design
- high video bandwidth — 120 Mhz (-3dB)
- multi-use touchscreen remote
- intuitive menu driven, multi-language interface with on-line help
- external computer control capability
- PHAST home automation system compatibility
- superior geometry control, contrast, astigmatism and color performance
- Contrast Modulation
- ASR and ASI to reduce the need for manual display adjustments
- ACON II automatic convergence feature

Functional ► **Description**

The projector accepts data/graphics and video input signals from a variety of sources for projection onto flat, curved, or rear projection screens. System inputs are processed to provide separate red, green, and blue image components for projection through the projector's three front lenses. The three primary color components converge on the projection screen to provide a high quality display output.

Sophisticated processor-based logic and control circuitry provide many of the automatic features available on the MP-8 and MP-9. This circuitry interfaces with the keypad and remote control to provide projector control by the user, such as:

- turning the projector on or off
- switching input sources
- adjusting all display settings such as contrast, brightness, and size
- correcting for display effects and input noise
- displaying projector operating status screens and on-line help
- controlling projector operating settings

Should projector servicing be required, service personnel can use the keypad to make service adjustments and alignments. In some cases the projector may be serviced without accessing the projector's internal circuitry. Projector settings, usually different for different sources, are stored in memory for each individual source. These settings are retained until changed by the user, even if power is removed from the projector.

Construction ➤ The projector body is comprised of a sturdy metal chassis, metal top covers, and durable plastic side covers. The front top cover can be temporarily removed to access the keypad and align the lenses. The rear top cover and rear panel are removable for servicing and projector upgrading.

Expandability ➤ Madrigal Imaging projectors can be expanded or upgraded to include additional features, accessories, and input options; these include a variety of quick plug-in interface modules to suit the input devices you are using, a signal switcher, a video decoder, a ceiling mount, and floor mount accessories. For more information or if you need assistance for upgrading your projector, contact your dealer or Madrigal Imaging.

1.2 Purchaser's Record and Servicing

Whether the projector is under warranty or the warranty has expired, Madrigal Imaging's extensive factory and dealer service network is always available. Madrigal Imaging service technicians are fully trained to quickly diagnose and correct projector malfunctions. Complete service manuals and updates are available to service technicians for all new projector models manufactured by Madrigal Imaging.

If you have a problem with your projector or require assistance, contact the authorized Madrigal Imaging dealer from which the projector was purchased. Fill out the information below for your records.

Purchaser's Record

Dealer:
Dealer Phone Number:
Projector Serial Number:
Purchase Date:

Note: Display projector serial# by pressing  at presentation level.

Madrigal Imaging Service Location

Madrigal Audio Laboratories, Inc.
2081 South Main Street
P.O. Box 781
Middletown, CT 06457
Telephone: (860) 346-0896
Fax: (860) 346-1540

Installation & Setup

This section explains how to install and set up the projector. If you are familiar with the projector and want to quickly set it up for temporary use, follow the Quick Setup instructions in section 2.1. For a complete setup, skip section 2.1 and follow the instructions and guides covered in the remaining subsections.

2.1 Quick Setup Follow these 7 steps for quick set up of the projector:

Step 1 ➤ Position the Projector

To perform a quick setup, the projector must be positioned so that the throw distance is the same as that used during the most recent optical alignment; otherwise a detailed setup is required. The throw distance is the distance between the center lens on the projector and the center of the projection screen. See Appendix F and Appendix G for more information. *Note: If an optical lens alignment is required, refer to section 2.8, Optical Alignment.*

Step 2 ➤ Connect the Power Cord

Plug the AC line cord into the line input unit on the lower front panel of the projector. Plug the three prong end of the line cord in a grounded AC outlet. *Notes: 1) Input voltage must be between 90 VAC and 264 VAC. 2) Ensure the line cord is the proper type for the AC receptacle.*

Step 3 ➤ Connect a Source

Connect a source to the projector's RGB input. Ensure the source is on and properly connected.

Step 4 ➤ Access the Keypad

Remove the projector's front top cover to access the keypad. See page 3-2.

Step 5 ➤ Turn the Projector On

Press **POWER** on the keypad to turn the projector on. Hold down the power key for about one second. *Note: If the keypad has been configured for IR remote operation, point it towards the screen or the front of the projector.*

Step 6 ➤ Select the Input

Press **SOURCE** **0** **1** to select the source connected to the built-in RGB input.

Step 7 ➤ Adjust the Display

Press **HELP** **0** to select the Guided Source Setup tutorial.

2.2 Installation Considerations

Careful consideration should be given as to how and where the projection system is installed. Although the projector offers high performance, the final display quality will be compromised if the projector is not installed properly. This subsection discusses the considerations you should make before proceeding with a final installation. These considerations include the installation type (floor, ceiling, rear), screen size and type, room lighting, and ventilation.

Installation Type ➤ Choose the installation type which suits your needs: front or rear screen, floor mount or ceiling mount.

Front Screen, Floor Mount Installation

ADVANTAGES	CONSIDERATIONS
<ul style="list-style-type: none"> • Easy to set up. • Can be moved or changed quickly. • Easy to access projector. 	<ul style="list-style-type: none"> • Shares floor space with audience. • May be accidentally moved, necessitating alignment.

Front Screen, Ceiling Mount Installation

ADVANTAGES	CONSIDERATIONS
<ul style="list-style-type: none"> • Does not take up audience space. • The projector is less noticeable. • The projector cannot be accidentally moved. 	<ul style="list-style-type: none"> • Installation is more permanent. • It is more difficult to physically access the projector.

Rear Screen, Floor Mount Installation

ADVANTAGES	CONSIDERATIONS
<ul style="list-style-type: none"> • Projector is completely hidden from the audience. • Easy to access projector. • Usually good ambient light rejection. 	<ul style="list-style-type: none"> • Requires separate room.

Rear Screen, Ceiling Mount Installation

ADVANTAGES	CONSIDERATIONS
<ul style="list-style-type: none"> • Projector is completely hidden from the audience. • Usually good ambient light rejection. 	<ul style="list-style-type: none"> • Requires separate room. • Installation cost is usually higher.

Rear Screen, Floor Mount With Mirror

ADVANTAGES	CONSIDERATIONS
<ul style="list-style-type: none"> • Projector is completely hidden. • Usually good ambient light rejection. • Less space is required behind the screen than other rear screen installations. 	<ul style="list-style-type: none"> • Requires separate room. • Installation cost is usually higher.

Screen Type ➤ Screen type is a very important factor when designing a projection system. Inexperienced users or installers should always consult their dealer when deciding on screen type. The following guidelines may be helpful to understand the differences between screen types.

Front Screen Installations

There are two basic screen types: flat and curved. The choice between a flat screen versus a curved screen is dependent on audience viewing angle and screen gain. There is always a trade-off between viewing angle and gain. Viewing angles for both screen types are illustrated in Figures 2-1 and 2-2.

Flat screens offer a gain of about 1 with a viewing angle just less than 180°. Incident light reflects equally in all directions so the audience can see the display from various angles. Because of the lower gain, flat screens are more effective when ambient lighting is reduced.

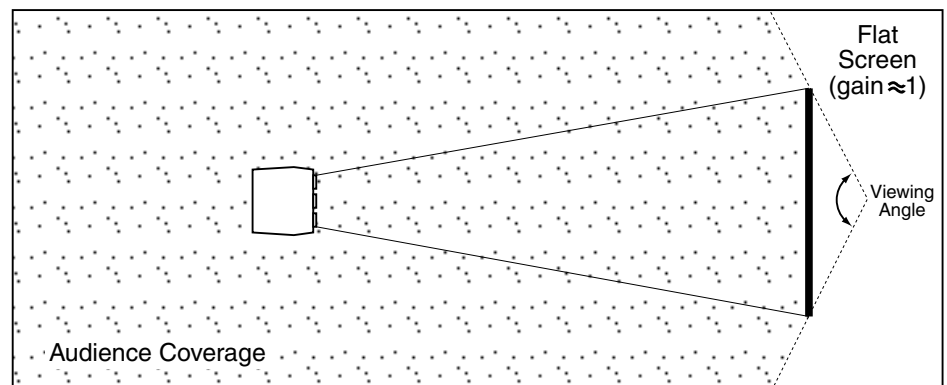

Figure 2-1. Audience Coverage with Flat Screen

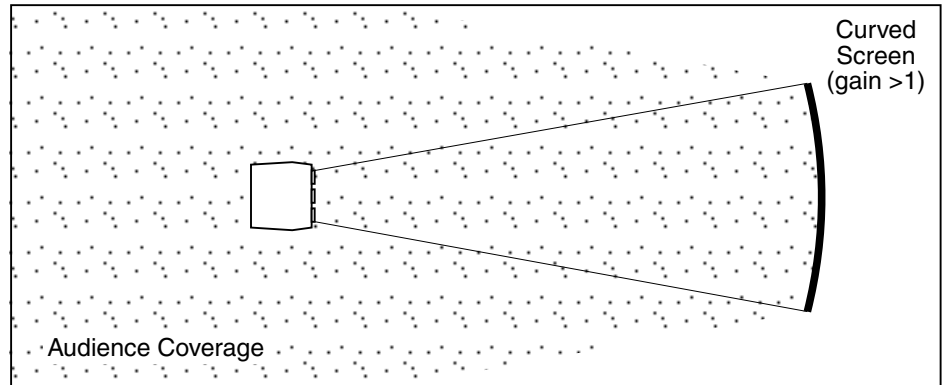

Figure 2-2. Audience Coverage with Curved Screen

Curved screens have gains larger than 1 and viewing angles much less than 180° . Most curved screens have different horizontal and vertical viewing angles. Incident light does not reflect equally in all directions. The reflected light concentrates in a conical volume or “viewing cone”. Audiences within the viewing cone see a brighter image than that from an equal area on a flat screen. Audiences outside the viewing cone see a dimmer image.

To summarize, curved screens are better suited for brightly lit rooms where the audience is situated within the viewing cone. Flat screens are best suited when a wide viewing angle is required and ambient room lighting (near the screen) is low.

Note: Screen Gain is defined in Appendix A, Glossary.

Rear Screen Installations

There are two basic types of rear screens: diffused and optical. A diffused screen has a surface which spreads the light striking it. Purely diffused screens have a gain of less than 1. The main advantage of the diffused screen is its wide viewing angle, similar to that of a flat screen for front screen projection.

Optical screens take light from the projector and redirect it to increase the light intensity at the front of the screen. This reduces it in other areas. A viewing cone, similar to that of a curved front screen installation, is created.

To summarize, optical screens are better suited for brightly lit rooms where the audience is situated within the viewing cone. Diffused screens are best suited when a wide viewing angle is required but there is low ambient room lighting.

Screen Size and Throw Distance ►

Screen size and throw distance are interrelated. (See Appendices F and G.) As screen size increases, the distance between the projector and the screen also increases. During projection room design, make sure that the room can accommodate the required position of the projector for the screen size you need.

Screen Size

Screen sizes vary according to model and lens type. (See Appendices F and G.) Choose a screen size which is appropriate for your application. If the projector will be used to display text information it is important that the image size allows the audience to clearly resolve all text. The eye usually sees a letter clearly if eye-to-text distance is less than 150 times the height of the letter. Small text, located too far from the eye, may not be legible at a distance even though it is projected sharply and clearly on the screen.

To fill a screen with an image, the aspect ratio of the screen must be equal to the aspect ratio of the image. The aspect ratio of an image is the ratio of its width to its height. Standard video from a VCR has a 4:3 or 1.33:1 aspect ratio. For example, to display a VCR output with a 4:3 aspect ratio onto a 10 foot (3m) high screen, the width of the screen must be at least 13.3 feet (4m).

Note: Screen size is often specified as diagonal size. Screens specified by diagonal size have aspect ratios of 4:3. Screens with other aspect ratios are not typically specified by diagonal size.

Throw Distance

The throw distance (projector-to-screen distance) must be determined for every new installation. Throw distance, the distance between the projector's center lens and the center of the screen, is based on screen size. As screen size increases, the distance between the projector and the screen increases. Make sure that the room can accommodate the required position of the projector for the chosen screen size.

Once your screen size is known you can determine the required throw distance for your projector model and lens by using the formulas in Appendix G and tables in Appendix F.

Notes: 1) Calculated values are for reference only. It is good practice to simulate the setup to determine the necessary throw distance. 2) Display size is affected by input signal characteristics. Once the projector is set, use the Size function to fine tune display size.

Throw distance and projection angle: Keep in mind that the ability to properly focus all areas of the image is limited if a significantly tilted projector is too close to the screen.

Lighting ➤ Proper lighting is another important factor when designing a projection room. Visiting a movie theatre can give you an idea of what makes a good projection environment. All walls, floors and furnishings are dull colored and non-reflectively finished. Every effort should be made to create the best environment for your system.

When designing a projection room, try to avoid white, reflective ceilings and non-directional lighting such as fluorescent lights. The white ceiling spreads the light which makes the room appear brighter. You want to keep the lighting and reflections to a minimum. Spot lighting is a better way to obtain illumination. Installing light dimmers allows you to control your lighting environment.

Outside windows are undesirable in any projection environment. A small crack between curtains on a sunny day can severely wash-out an image. Make sure that curtains are opaque and fit snugly. Some curtains can provide up to 100 percent blockage of outside light. Pay close attention to the curtain material facing inside the room. It should have a matte finish.

Even with no external light at all, reflections from room surfaces can degrade the image. Light from the screen should be absorbed by surfaces so that it will not be reflected back to the screen. Keep reflective surfaces to a minimum.

To minimize the effects caused by unwanted light from door and aisle ways, carefully choose the position of your projector and screen. Figure 2-3 shows an installation where poor screen placement has allowed too much unwanted light to enter the screen. In Figure 2-4, the screen and the projector are positioned so that unwanted light is minimized.

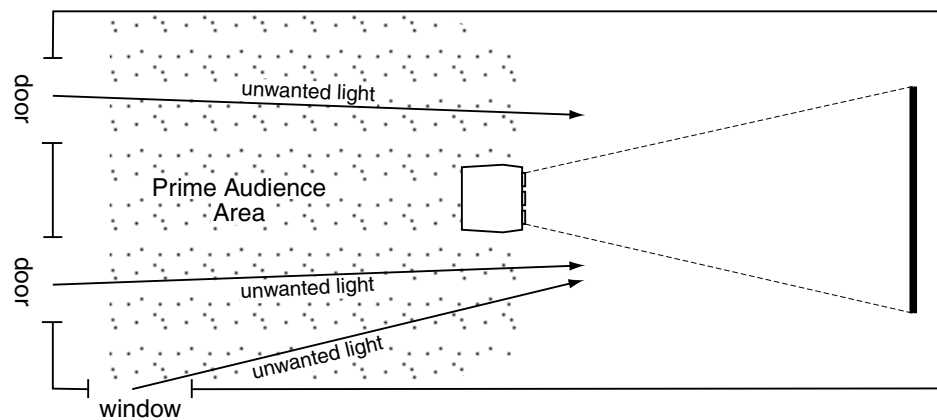

Figure 2-3. *Poor Screen Placement*

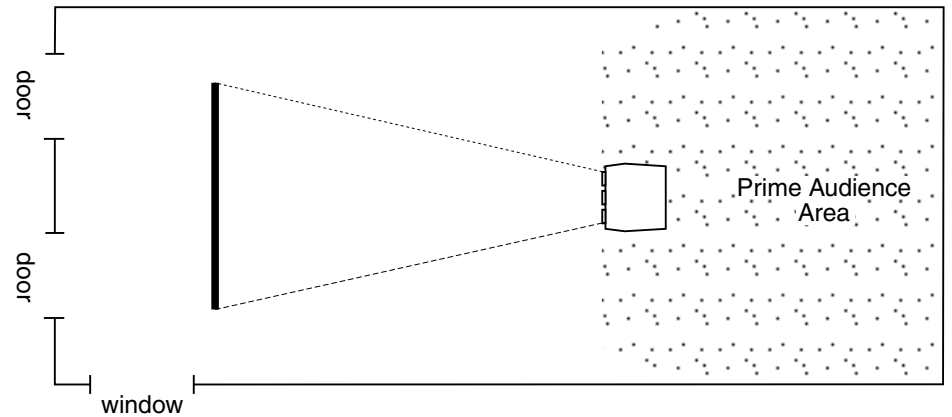

Figure 2-4. Good Screen Placement

Other Considerations ➤

Here are some other considerations and tips which can help you improve the design of your projection system.

- ❑ Proper ventilation is important. The ambient temperature should be kept constant and below 35° C (95° F). Keep the projector away from heating and/or air conditioning vents. Changes in temperature can cause drifts in the projector circuitry which may affect performance.
- ❑ Keep the projector away from devices which radiate electromagnetic energy such as motors and transformers. Common sources of these are slide projectors, speakers, power amplifiers, elevators, etc. Keep 35 mm slide projectors at least 2 feet away from the projector. Even if both are not used at the same time, the magnetic fields created by the slide projector can cause permanent magnetization of the projector.
- ❑ For rear screen applications, less space is required if a mirror is used to fold the optical path.
- ❑ Choose the right screen size for your application:
 - As screen size increases, magnification increases which reduces brightness. This reduces the contrast ratio which affects legibility. Sharp defined edges become soft and fuzzy. Consider whether screen size is more important than these other vital picture characteristics.
 - Installing a large screen in a small room is similar to watching television close up; too large a screen can overpower a room. A good rule of thumb is to be no closer than two times the height of the screen.
 - Larger screens require greater attention to lighting conditions.
- ❑ When laying out your projection room, consider positioning the projector and screen in a manner which will achieve maximum audience coverage and space efficiency. For example, placing the screen along the larger wall in a rectangular room will reduce audience coverage. Figure 2-5 shows two examples of how audience coverage is maximized.

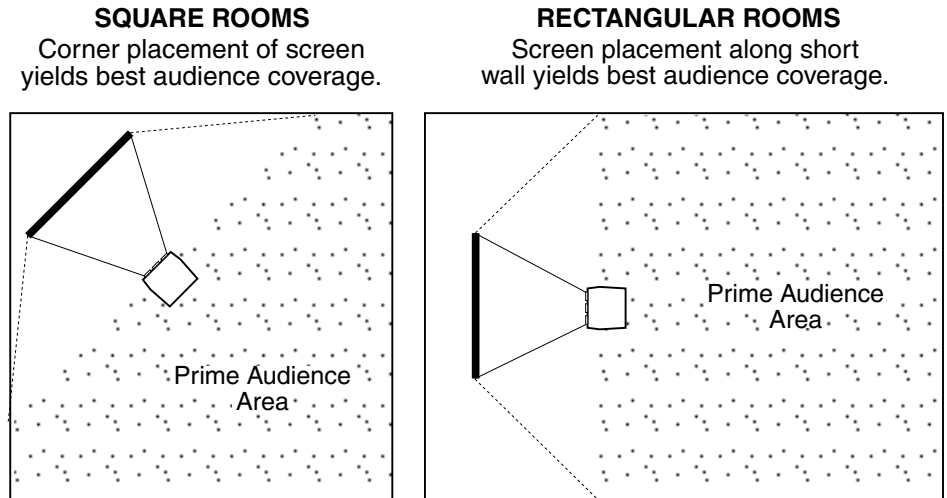

Figure 2-5. *Screen Locations for Maximum Audience Coverage*

2.3 Hardware Setup

This section explains: how to convert the keypad from a built-in keypad to a remote keypad, how to change keypad protocol and backlit settings, and how to determine if reverse scan setup is required.

Keypad Conversion ➤

The projector includes a multi-use full-function keypad which may be configured for use as a built-in, IR remote, or wired remote keypad. The keypad is configured at the factory for built-in use. It is located below the front top cover. You can use the keypad as it is or re-configure it for remote operation. You can also “hard wire” the keypad to be a protocol A or protocol B keypad (see section 3.7, *Utility Features* for information about keypad protocols).

Follow the steps below to convert the keypad to a remote keypad and change its protocol setting.

Step 1

Unplug the projector then lift the front top cover to access the built-in keypad. To lift the cover, grasp it above the red and blue lenses then lift it until the keypad is exposed. The keypad is mounted to a securing bracket located above the lens assemblies. Loosen the two bracket wing nuts then move the keypad away from the bracket. See Figure 2-6.

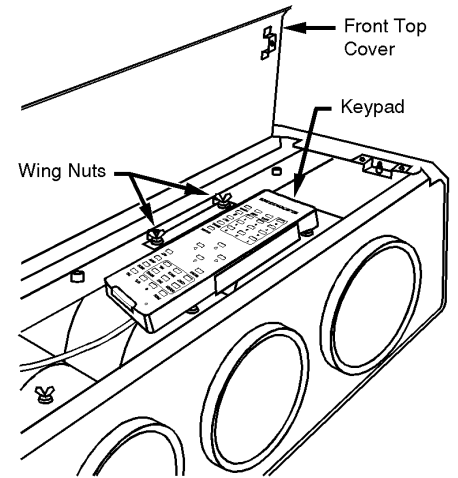

Figure 2-6. Built-in Keypad Access

Step 2

Locate the battery compartment at the back side of the keypad. Squeeze the latch to open the door. See Figure 2-7.

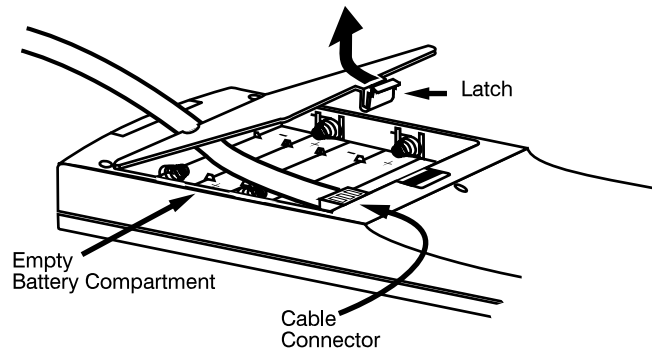

Figure 2-7. Battery Compartment

If converting the keypad to an IR remote, unplug the cable connector. Locate the jumper wires next to the cable connector location. See Figure 2-8. The jumper wires control the keypad's operating settings.

JP1	3 2 1	PROTOCOL A
	3 2 1	PROTOCOL B
JP2	3 2 1	(ALWAYS)
JP3	3 2 1	(ALWAYS)
JP4	3 2 1	BUILT-IN OR WIRED KEYPAD
	3 2 1	IR REMOTE KEYPAD

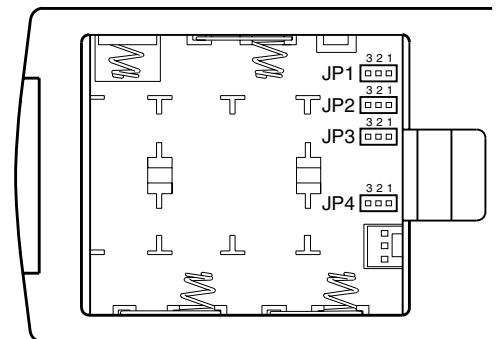





Figure 2-8. Jumper Settings

JP1

This jumper setting is important if the keypad is configured for remote operation. There are two keypad protocols: A and B. These protocols are available to allow two projectors in the same room to be independently controlled by separate remote keypads. The protocol setting of the keypad must match that set in the projector's Keypad Options menu (  ). For more information about keypad protocols, refer to the *Remote Control Options* entry in section 3.7, *Utility Features*.

JP2

This jumper must always be set between pins 1 and 2 as shown; otherwise, the projector will not respond correctly to keypad commands.

JP3

This jumper must always be set between pins 1 and 2 as shown; otherwise, the backlit feature will be disabled and the projector will not respond correctly to keypad commands.

JP4

The JP4 jumper setting sets the keypad type. If you are converting the keypad to an IR remote, move the JP4 jumper from between pins 2 and 3 to between pins 1 and 2.

Step 3

For an IR remote keypad, place four AA size, 1.5V alkaline batteries in the compartment ensuring that the +/- orientation of each battery is correct. Position the compartment door into place.

For a wired remote keypad, an optional accessory cable (#03-001106-02P) is required. Plug the cable into the cable connector then position the door into place. Plug the cable jack into the remote jack input on the projector.



WARNING: DO NOT INSTALL BATTERIES IN THE KEYPAD IF A BUILT-IN OR WIRED REMOTE CABLE IS ATTACHED TO IT. THIS MAY CAUSE THE BATTERIES TO EXPLODE.

Keypad Operating ► Settings

The keypad includes its own memory to store keypad operating settings. With a few simple keystrokes you can over-ride the “hard wire” protocol setting (explained earlier) and enable or disable the backlit feature. Keypad battery life is increased if the backlit feature is disabled. The new operating settings are stored in the keypad until the batteries are replaced (IR remote keypad) or the keypad connection cable is unplugged (wired or built-in keypad).

If the keypad is configured for IR remote operation, make sure the batteries are installed. If it is configured for built-in or wired remote operation, make sure its extension cable is properly connected to the projector. Perform the following keystroke sequences to change its operating settings:



- To toggle the keypad’s protocol setting (A or B), press **⌘** **BRITE** **TINT** **DETAIL** **1**.
- To toggle the backlit feature (enable or disable), press **⌘** **BRITE** **TINT** **DETAIL** **3**.
- To return all configuration settings to the jumper settings, press **⌘** **BRITE** **TINT** **DETAIL** **0**.

*Note: The projector will not respond to keypad commands if you press **⌘** **BRITE** **TINT** **DETAIL** **2**. If pressed accidentally, press **⌘** **BRITE** **TINT** **DETAIL** **0** to clear all keystroke settings.*

Reverse Scan ➤

If the projector is not installed in a front screen, floor mount configuration, reverse scan setup may be required. Reverse scan setup must be performed by a qualified Madrigal Imaging service technician. Refer to Table 2-2 to determine if reverse scan setup is required. Contact your dealer for assistance.

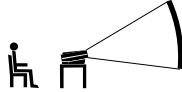
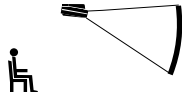
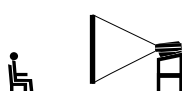
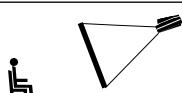
Table 2-2. *Operating Configurations*

OPERATING CONFIGURATION		HORIZONTAL SCAN	VERTICAL SCAN
	Front Screen, Floor Mount (default configuration)	NORMAL	NORMAL
	Front Screen, Ceiling Mount	REVERSED	REVERSED
	Rear Screen, Floor Mount	REVERSED	NORMAL
	Rear Screen, Ceiling Mount	NORMAL	REVERSED
	Rear Screen, Floor Mount, With Mirror	NORMAL	NORMAL

2.4 Mounting

The projector should be mounted after the system design has been established and reverse scan setup (if required) is complete.

Front Screen ► Installations

Floor Mount

Mount the projector on a secured table or cart. Position the projector at the chosen room location with the projector pointing towards the center of the projection screen. The angle of projection, combined with the tilt angle of the screen should direct the reflected image towards the center of the audience. It is recommended that the difference between the projection angle and the screen tilt angle (within a common reference) be less than 15°. Refer to Figure 2-9.

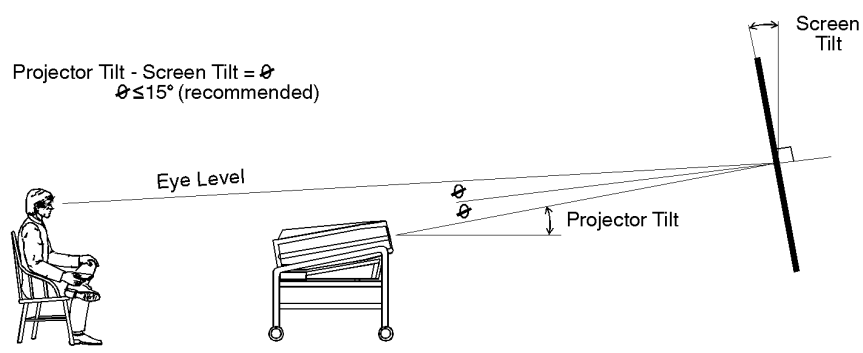

Figure 2-9. Floor Mount Installation

You can adjust projection angle and level by adjusting the height of the projector legs. See Figure 2-10.

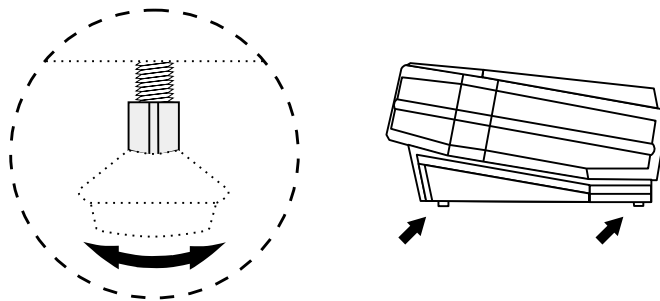

Figure 2-10. Leg Adjustment

Ceiling Mount

Mounting the projector to the ceiling requires the use of a projector ceiling mount fixture. The fixture is shipped from the factory in kit form (with assembly instructions) for assembly and installation by the dealer/installer. For more information, contact your dealer or Madrigal.

Position the projector so that it is pointing toward the center of the projection screen. The angle of projection combined with the tilt angle of the screen should direct the reflected image towards the center of the audience. It is recommended that the difference between the projection angle and the screen tilt angle (within a common reference) be less than 15°. See to Figure 2-11.

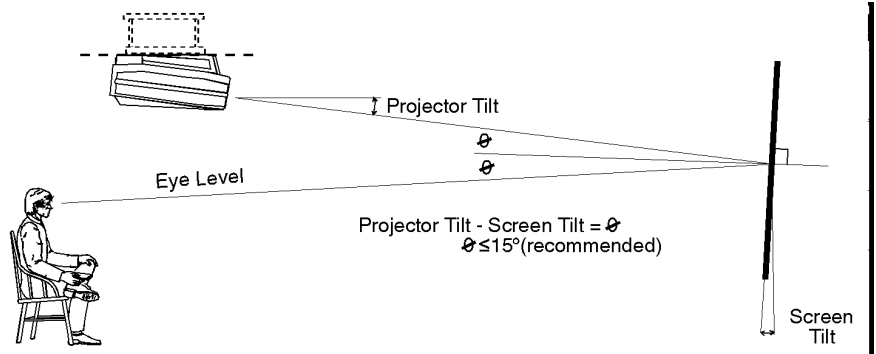

Figure 2-11. *Ceiling Mount Installation*

Instructions for adjusting projection angle are provided with the fixture kit. For more information, contact your dealer or Madrigal.

Rear Screen Installations ➤

When installing a rear screen system, the vertical positioning of the projector is dependent on the type of rear screen being used. There are two basic types of rear screens: optical and diffused.

Optical Rear Screen Systems

If the system includes an optical rear screen, mount the projector along the center axis of the screen as shown in Figure 2-12.

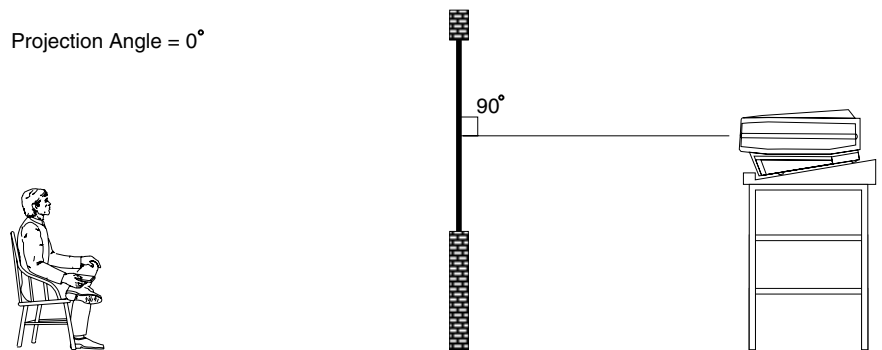

Figure 2-12. *Optical Rear Screen Installation*

Diffused Rear Screen Systems

If the system includes a diffused rear screen, floor mount or ceiling mount the projector so that the image is directed to the center of the audience. Projection tilt should be less than 15°. See Figure 2-13.

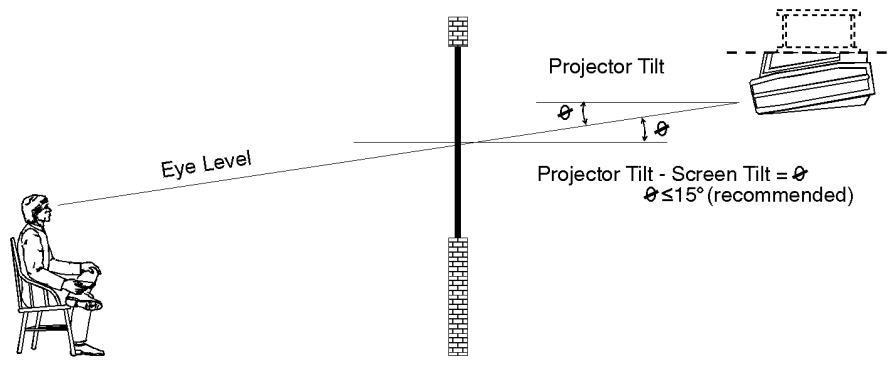

Figure 2-13. *Diffused Rear Screen Installation*

In situations where the space behind the projector is limited, a mirror may be used to fold the optical path as illustrated in Figure 2-14. If a diffused screen is used, the projection angle θ should be less than 15°. If an optical screen is used, the optical path between the mirror and the screen should be perpendicular to the screen. Much attention must be given to the positioning of the projector and the mirror. This can be quite difficult for installers unfamiliar with this type of installation. It is recommended that your dealer or an experienced installer perform the installation.

Note: When using a mirror as shown in Figure 2-14, the calculated throw distance (D) is the summation of D1 and D2.

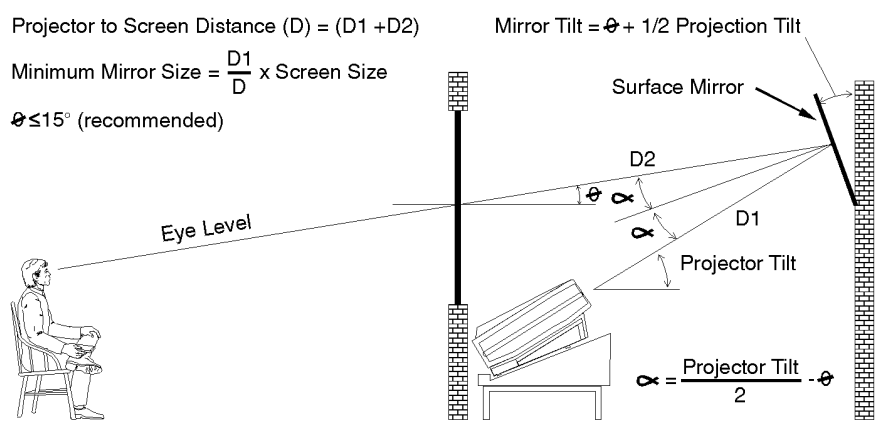

Figure 2-14. *Folded Optics*

2.5 Power Connection

To apply power to the projector, plug the AC line cord into the line input socket located at the front panel of the projector. Plug the three prong end of the line cord in a grounded AC outlet. Input voltage to the projector must be between 90 and 264 VAC, 50 or 60 Hz. The power source must supply 650 watts of power to the projector.

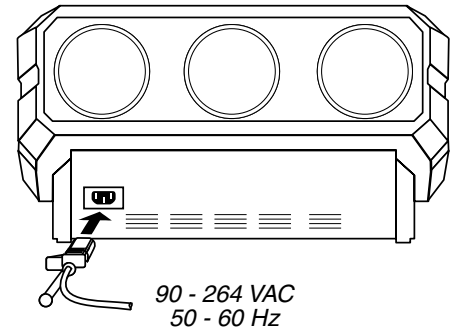

Figure 2-15. Power Connection

2.6 Source Connections

The projector includes a built-in RGB input interface for connection of external RGB sources and audio equipment. This input interface is shown in Figure 2-16. The built-in interface is not removable.

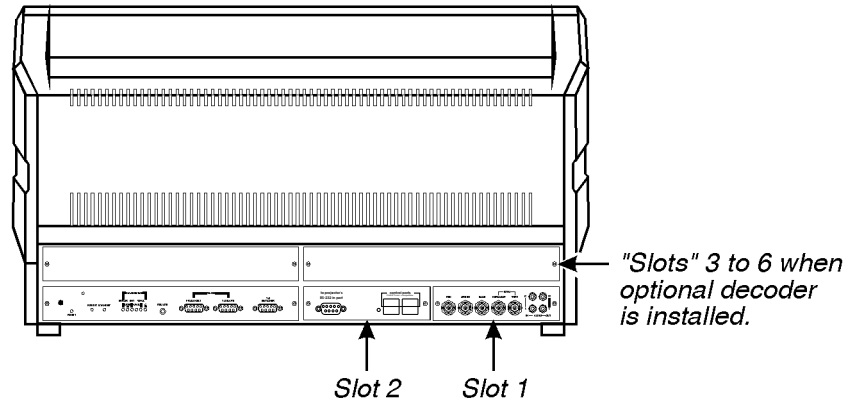

Figure 2-16. Projector Input Slots

Optional interface modules are available to accommodate other signal types. These include a Composite/S-Video Module, an HDTV Input Module, and a PC Analog Input Module. Any one of these can be installed in slot 2. A Multi-Standard Decoder may be installed to add four additional inputs to the system (“slots” 3 to 6). To further increase the number of inputs, a signal switcher may be connected to the RGB interface in slot 1 to add 8 more sources to the system (9 switcher inputs replace one RGB input). Other switchers may be connected to the first switcher for more inputs. Brief descriptions of the above mentioned optional modules are given in Appendix H, *Interfaces*. For additional details, contact your dealer or Madrigal.

The RGB interface allows connection of an RGB source having one of the following sync types: sync on green, composite sync, or separate H & V sync. To connect a source, connect the red, green, and blue outputs to the RED, GREEN, and BLUE inputs on the interface. If the source uses sync on green, no additional cables are required. If the source provides a composite sync output, connect it to the HOR/COMP input. If the source provides separate horizontal and vertical sync outputs, connect the horizontal sync signal to the HOR/COMP input, and connect the vertical sync input to the VERT input. Interconnection cables must be terminated with BNC connectors. Figure 2-17 show source connections for the built-in interface.

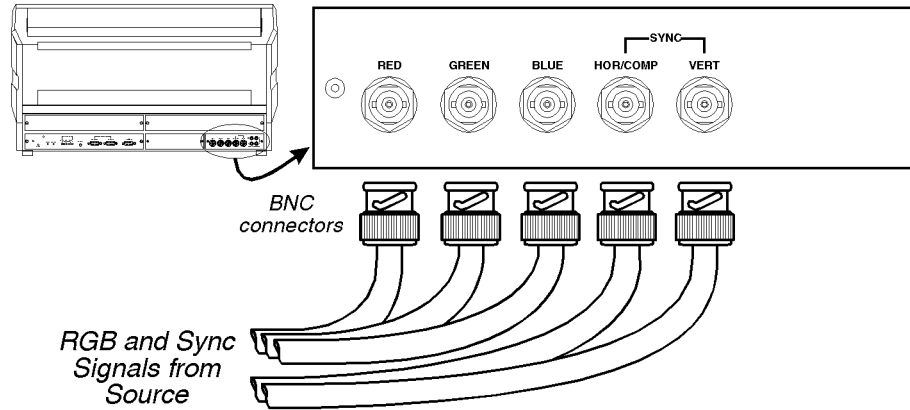

Figure 2-17. Built-in RGB Interface Connections

2.7 Serial Port Connections

Serial port connections are required when the projector is to be controlled by a computer/controller other than PHAST.

The projector's serial ports are located on the back panel. See Figure 2-18.

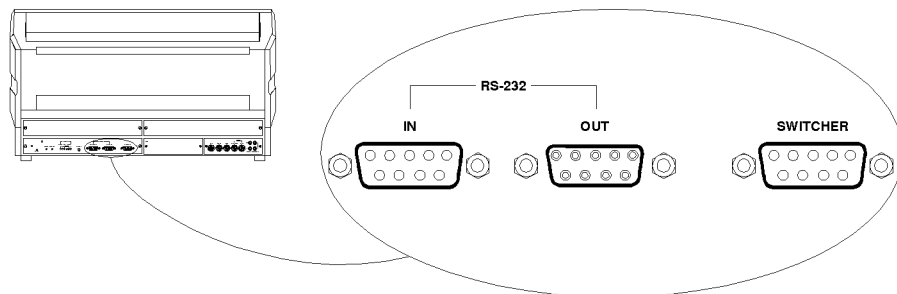

Figure 2-18. Serial Port Connections

If the projector is to be controlled by a computer or controller which has an RS-232 serial port, connect an RS-232 serial cable between the computer and the projector serial port labeled "IN". After the connection is made, set the serial port baud rate as described in the Projector Setup entry in section 3.7, *Utilities*.

Notes: 1) All serial connections require a 9 pin D connector at the projector end. Refer to Appendix D for cable wiring requirements. 2) For computer/controller control, PC software is required. 3) The RS-232 serial port labeled "OUT" is provided for projector networking applications.

2.8 Optical Alignment

Optical alignment is required when the throw distance changes or the projector cannot be focused using the focus controls. The projector is optically aligned at the factory at a fixed screen size and a fixed projector-to-screen distance. See Appendices F and G for the specific details needed for your projector model and lens. If the throw distance has changed since the last setup, proceed as follows:

Notes: 1) The projector must be warmed up for at least 45 minutes prior to performing optical alignment. 2) Optical alignment is both a mechanical and electrical adjustment. Electrical adjustments are stored in the current setup memory. After alignment is complete, setup memories which were previously set up (if any) must be set up again. Memory setup is explained in section 2.10. 3) Factory alignment is performed using the internal crosshatch with a 61.8 kHz signal applied.

It is recommended that optical alignment be performed using the projector's Guided Mechanical Setup tutorial. This tutorial displays step-by-step instructions during the alignment. The instructions in this section require use of the Guided Mechanical Setup tutorial.

To access and use the Guided Mechanical Setup tutorial, turn on the projector (**POWER**) then press **HELP** at operation level. The Help menu is displayed. Next press **2** to select Guided Mechanical Setup. The first page of the guide will be displayed on the projection screen. When using the guide, press **HELP** to display the next page, press **RECALL** to display the previous page. When complete, press **EXIT** to end Help.

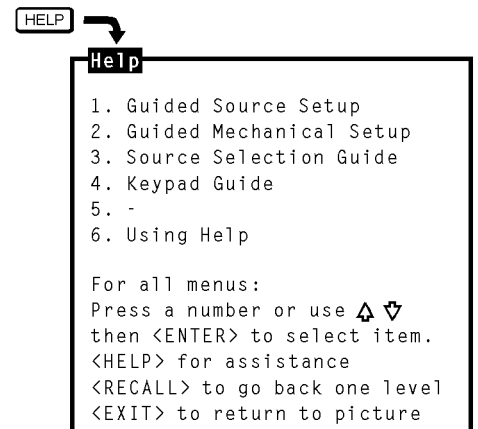

- Step 1** ➤ If you have not already done so, calculate the throw distance and set the projector position as explained in section 2.4, *Mounting*. Turn power off before moving the projector.

Step 2 ➤ Locate the front top cover of the projector. See Figure 2-19. Next, position your hands above the red and blue lenses then grasp the cover. Gently lift it until it is released from its securing latch. Slide the cover away from the projector as shown in Figure 2-20 below.

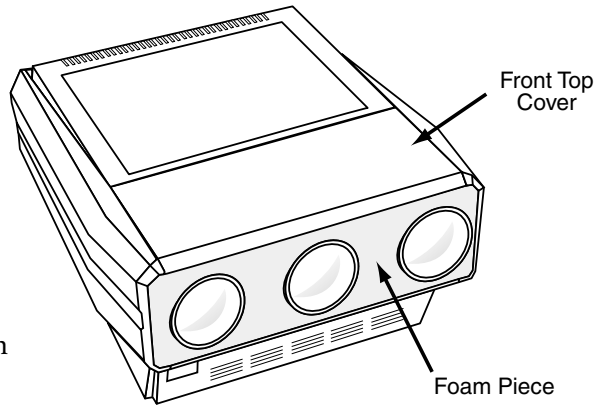

Figure 2-19. *Front Top Cover*

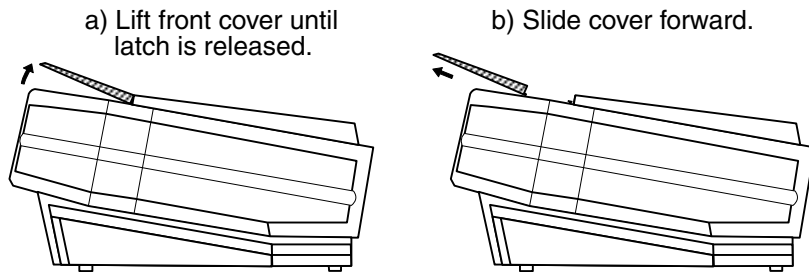

Figure 2-20. *Front Top Cover Removal*

Also remove the black decorative foam piece at the front of the lenses (removal is optional). Remove the large allen head driver from the tool kit provided with the projector. The driver is used for lens alignment.

Examine the lenses and hardware as shown in Figure 2-21a (or, for the MP-8 model, see Figure 2-21b). Each lens consists of a rear section and a front section. The rear section sets the optical focus at the center of the image and is secured to the lens body by a wing nut at the top rear of the lens assembly. The front section sets the focus at the corners and is secured to the rear section by a wing nut at the top front of the lens assembly.

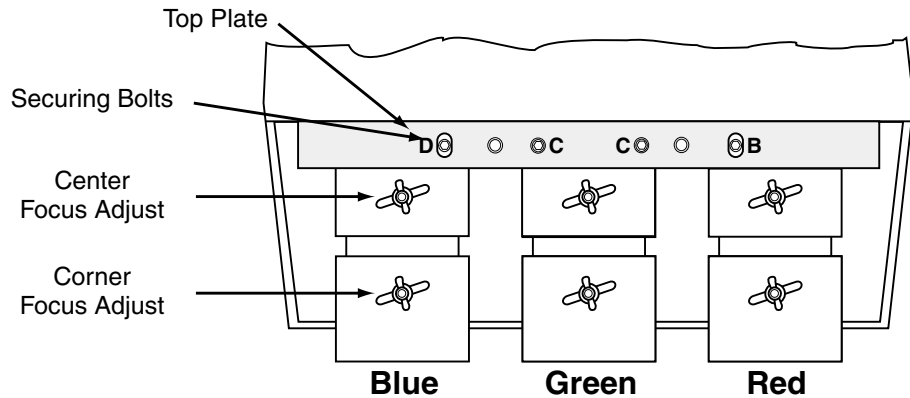

Figure 2-21a. *MP-9 Lens Assemblies - Top View*

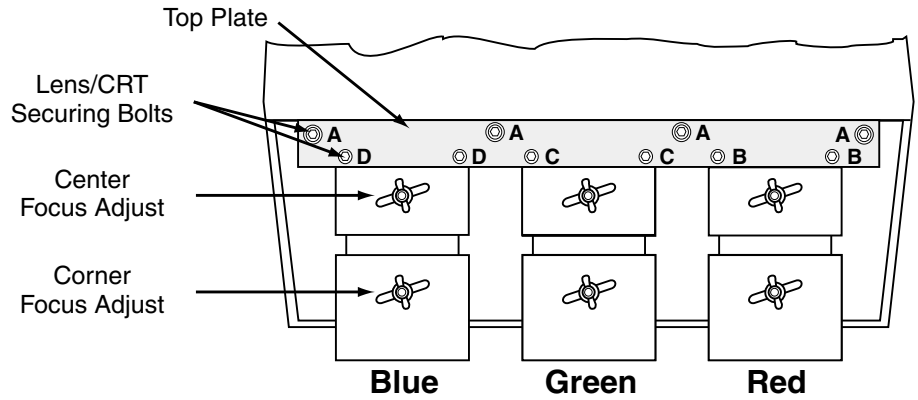

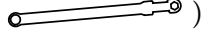

Figure 2-21b. *MP-8 Lens Assemblies - Top View*

For the MP-9: The lenses are secured to the projector frame by a top plate and individual mounting plates as shown in Figures 2-21a and 2-22a. During optical alignment, adjust the top plate securing bolts using the ball nose screw driver () supplied with the projector. Adjust the mounting plate securing bolts using either the ball nose screwdriver or the projector wrench () supplied, as necessary. The securing bolts are labeled B-C-D.

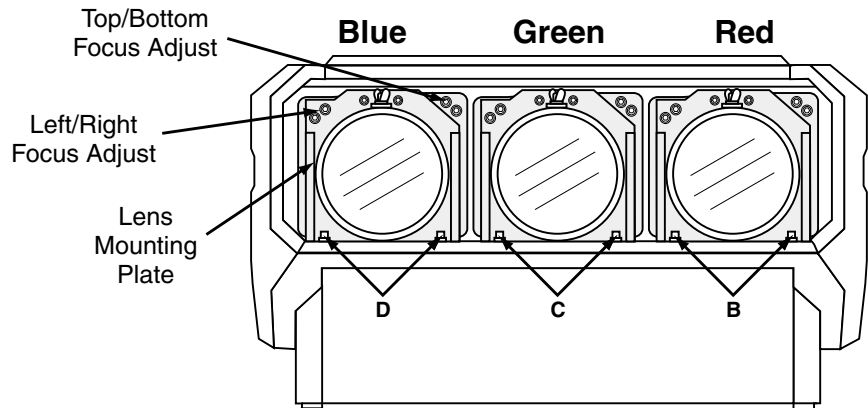

Figure 2-22a. *MP-9 Lens Assemblies - Front View*

For the MP-8: The lenses are secured to the projector frame by a top plate as shown. During optical alignment, adjust the securing bolts as instructed — refer to Figures 2-21b and 2-22b. The securing bolts are labeled A-B-C-D.

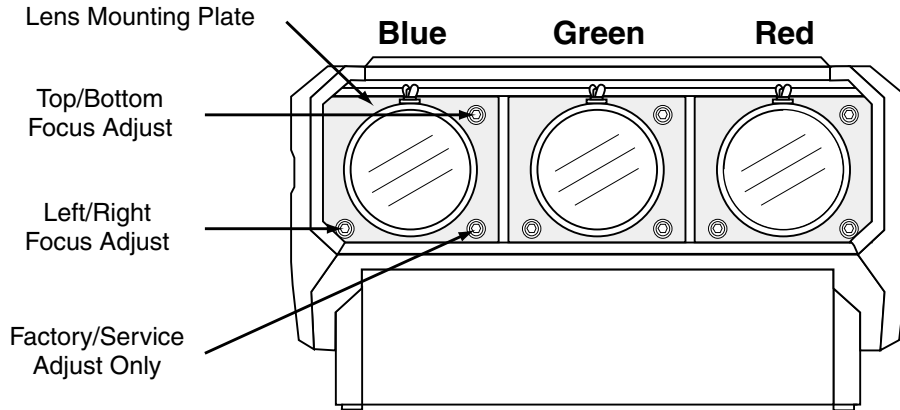
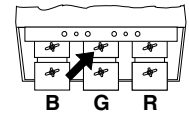

Figure 2-22b. MP-8 Lens Assemblies - Front View

For the MP-9, each CRT is attached to its lens by socket head allen screws located at each lens mounting plate. For each lens, the upper left screws (when facing the lens) adjust the focus between the left and right sides of the picture, and the upper right screws adjust the focus between the top and bottom of the picture. Use the supplied ball nose screw driver for these adjustments.

For the MP-8, each CRT is attached to its lens by 3 socket head allen screws located at each lens mounting plate. For each lens, the upper right screw (when facing the lens) adjusts the focus between the top and bottom of the picture, and the lower left screw adjusts the focus between the left and right sides of the picture. See Figure 2-22b.

- Step 3** ➤ Loosen the rear wing nut on the green lens. Rotate the lens using the wing nut until the picture is focused in the center. Tighten the rear wing nut.



- Step 4** ➤ Loosen the front wing nut on the green lens. Rotate the front lens barrel until the picture is focused in the corners. Tighten the front wing nut.

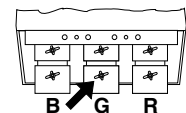









- Step 5** ➤ Steps 6 to 8 require that you look directly into the lenses for adjustment. Before you continue, press to reduce contrast to a low level (less than 10%).



WARNING: DO NOT LOOK INTO THE LENSES IF CONTRAST IS SET TO NORMAL VIEWING LEVEL.

- Step 6** ➤ Look directly into the red lens. Press , , or to center the displayed crosshatch on the face of the picture tube.

Step 7 ➤ Look directly into the green lens. Press , ,  or  to center the displayed crosshatch on the face of the picture tube.

Step 8 ➤ Look directly into the blue lens. Press , ,  or  to center the displayed crosshatch on the face of the picture tube.

Step 9 ➤ Press  to increase contrast to a normal viewing level.

Step 10 ➤ Pivot the projector and move it side to side as necessary to display a symmetrical crosshatch centered left-to-right on the screen. The pivot point should be at the rear wing nut of the green lens to avoid changing the throw distance.

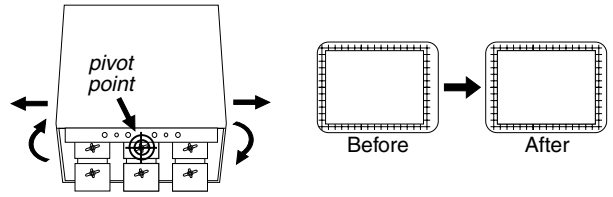

Step 11 ➤ Tilt the projector until the center horizontal line is level and centered with the screen. Adjust the feet of the projector or ceiling mount as required.

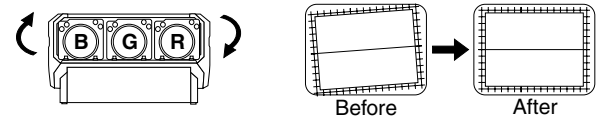

Step 12 ➤ A red image is displayed. Loosen the rear wing nut on the red lens. Rotate the lens using the wing nut until the picture is focused in the center. Tighten the rear wing nut.

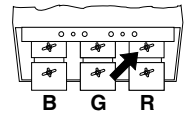

Step 13 ➤ Loosen the front wing nut on the red lens. Rotate the front lens barrel until the picture is focused in the corners. Tighten the front wing nut.

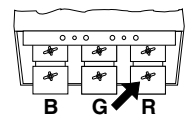

Step 14 ➤ A blue image is displayed. Loosen the rear wing nut on the blue lens. Rotate the lens using the wing nut until the picture is focused in the center. Tighten the rear wing nut.

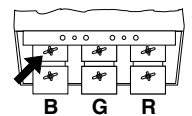

Step 15 ➤ Loosen the front wing nut on the blue lens. Rotate the front lens barrel until the picture is focused in the corners. Tighten the front wing nut.

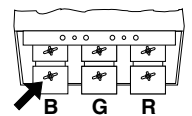

Step 16 ➤ Press  or  to adjust for best electrical focus at the center of the picture.

Step 17 ➤ On the MP-9, loosen the three bolts labeled “B”. One is located on the top plate. The other two are below the red lens.

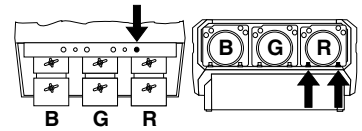

On the MP-8, loosen the four bolts labeled “A”.

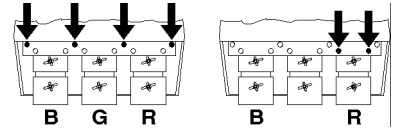

Loosen the two bolts labeled “B”.

Step 18 ➤ A red and green crosshatch is displayed. Move the red lens so that the left and right edges of the red crosshatch match the green.

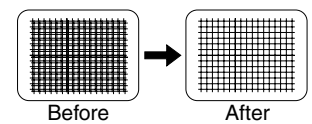

Step 19 ➤ On the MP-9, tighten the three bolts labeled “B”.

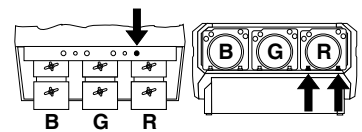

On the MP-8, tighten the two bolts labeled “B”.

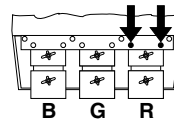

Step 20 ➤ On the MP-9, loosen the three bolts labeled “D”. One is located on the top plate. The other two are below the blue lens.

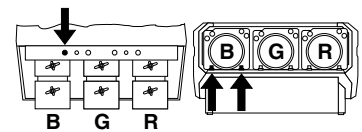

On the MP-8, tighten the two bolts labeled “D”.

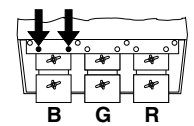

Step 21 ➤ A blue and green crosshatch is displayed. Move the blue lens so that the left and right edges of the blue crosshatch match the green.

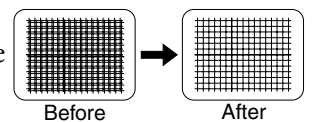

Step 22 ➤ On the MP-9, tighten the three bolts labeled “D”.

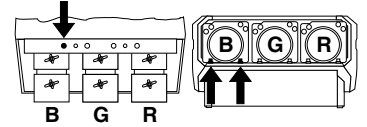

On the MP-8, tighten the two bolts labeled “D”.

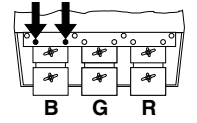

Step 23 ➤ A green image is displayed. Loosen the rear wing nut on the green lens and slightly defocus the center of the picture.

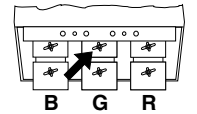

Step 24 ➤ On the MP-9, locate the two adjustment bolts at the upper right corner of the green lens mounting plate (viewed from the front). Adjust the two bolts until the top and bottom areas of the picture are equally defocused. Use the following technique for the adjustment: Turn the SIDE bolt 1/8 turn CCW. Turn the TOP bolt about 1/8 turn CW until it stops. If defocus at the top and bottom are equalizing, repeat until equal. If the top and bottom are not becoming equally defocused, use the same technique but instead turn the TOP bolt CCW then turn the SIDE bolt CW until it stops. Repeat until defocus is equal.

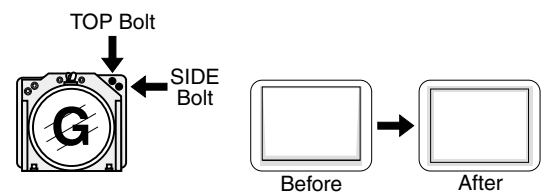

On the MP-8, adjust the large allen head bolt located at the upper right corner of the green lens mounting plate. Turn the bolt head until the top and bottom areas of the picture are equally defocused.

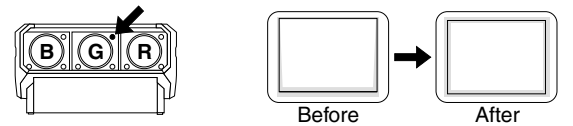

NOTE: On all models, it may be necessary to readjust the lens' rear wing nut to keep the center defocused.

Step 25 ➤ Rotate the green lens using the rear wing nut until the picture is focused in the center. Tighten the rear wing nut.

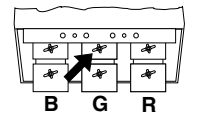

If necessary, loosen the front wing nut, rotate the front lens barrel to readjust the focus in the corners, then re-tighten the wing nut.

Step 26 ➤ A red image is displayed. Loosen the rear wing nut on the red lens and slightly defocus the center of the picture.

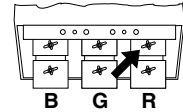

Step 27 ➤ On the MP-9, locate the two adjustment bolts at the upper right corner of the red lens mounting plate (viewed from the front).

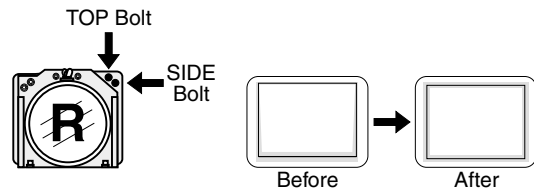

Adjust the two bolts until the top and bottom areas of the picture are equally defocused. Use the same technique as that used for the green adjustment (step 24).

On the MP-8, adjust the large allen head bolt located at the upper right corner of the red lens mounting plate. Turn the bolt head until the top and bottom areas of the picture are equally defocused.

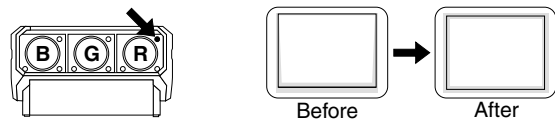

Note: On all models, it may be necessary to readjust the lens' rear wing nut to keep the center defocused.

Step 28 ➤ On the MP-9, locate the two adjustment bolts at the upper left corner of the red lens mounting plate (viewed from the front).

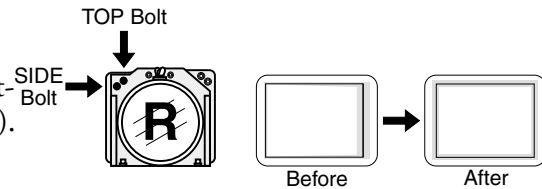

Adjust the two bolts until the left and right areas of the picture are equally defocused. Use the same technique as that used for the previous adjustment (step 27).

On the MP-8, adjust the large allen head bolt located at the lower left corner of the red lens mounting plate. Turn the bolt head until the left and right sides of the picture are equally defocused.

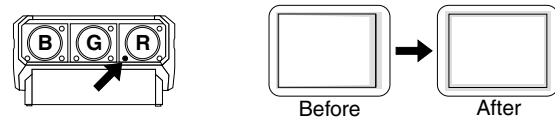

Note: On all models, it may be necessary to readjust the lens' rear wing nut to keep the center defocused.

Step 29 ➤ Rotate the red lens using the rear wing nut until the picture is focused in the center. Tighten the rear wing nut. If necessary, loosen the front wing nut, rotate the front lens barrel to readjust the focus in the corners, then re-tighten the wing nut.

Step 30 ➤ A blue image is displayed. Loosen the rear wing nut on the blue lens and slightly defocus the center of the picture.

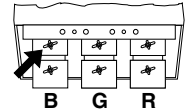

Step 31 ➤ On the MP-9, locate the two adjustment bolts at the upper right corner of the blue lens mounting plate (viewed from the front).

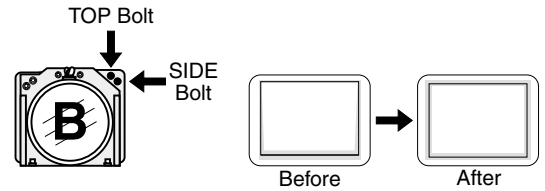

Adjust the two bolts until the top and bottom areas of the picture are equally defocused. Use the same technique as that used for the green and red adjustments.

On the MP-8, adjust the large allen head bolt located at the upper right corner of the blue lens mounting plate. Turn the bolt head until the top and bottom sides of the picture are equally defocused.

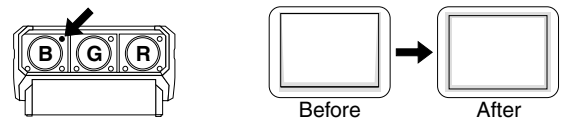

Note: On all models, it may be necessary to readjust the lens' rear wing nut to keep the center defocused.

Step 32 ➤ On the MP-9, locate the two adjustment bolts at the upper left corner of the blue lens mounting plate (viewed from the front).

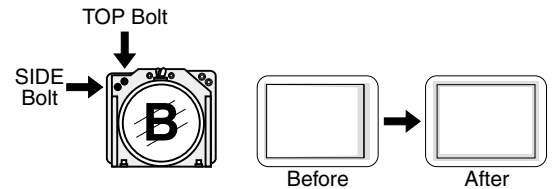

Adjust the two bolts until the left and right areas of the picture are equally defocused. Use the same technique as that used for the previous adjustment (step 31).

On the MP-8, adjust the large allen head bolt located at the lower left corner of the blue lens mounting plate. Turn the bolt head until the left and right sides of the picture are equally defocused.

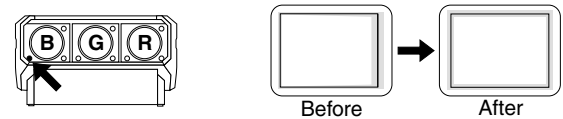

Note: On all models, it may be necessary to readjust the lens' rear wing nut to keep the center defocused.

Step 33 ➤ Rotate the blue lens using the rear wing nut until the picture is focused in the center. Tighten the rear wing nut.

If necessary, loosen the front wing nut, rotate the front lens barrel to readjust the focus in the corners, then re-tighten the wing nut. See Step 15.

Step 34 ➤ For the MP-9, optical alignment is now complete. If you had removed the foam insert, reinstall it now. Install the front top cover. Proceed to set up each source by following the source setup procedure in section 2.9, *Source Setup*.

On the MP-8, tighten the bolts labeled “A”. Optical alignment is now complete. If you had removed the foam insert, reinstall it now. Install the front top cover. Proceed to set up each source by following the source setup procedure in section 2.9, *Source Setup*.

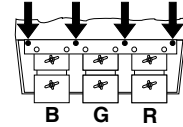

2.9 Source Setup



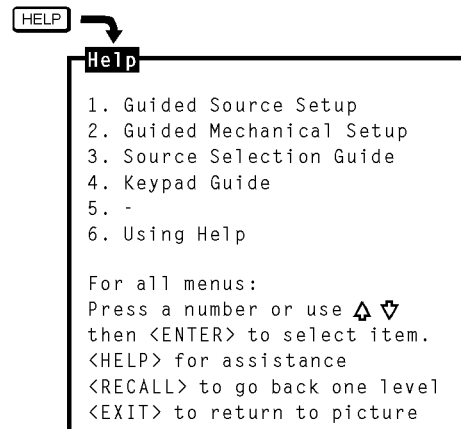

This section gives step-by-step instructions for quick setup of the projector for a selected external source. For a complete setup, repeat these steps as required for each source connected to the projector.

Before starting, ensure that the projector is optically and mechanically aligned. If optical alignment is required, follow the setup instructions in section 2.8, *Optical Alignment*. Select the source to be set up using the Source command and make sure it is visible on the projection screen.



To make setup easier, it is recommended that you use the projector’s Guided Source Setup tutorial. It provides source setup instructions on screen to guide you through the adjustments. To access the tutorial, first press **HELP** at operation level. The Help menu is displayed. Next press **1** to select Guided Source Setup. The first page of the guide will be displayed on the projection screen. When using the guide, press **HELP** to display the next page, press **RECALL** to display the previous page. When complete, press **EXIT**.



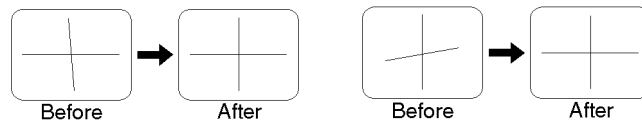

- Step 1** ➤ Press **BRITE** then **▲** or **▼** to increase or decrease the brightness setting until black areas in the image just disappear.
- Step 2** ➤ Press **CONT** then **▲** or **▼** to adjust the contrast of the image to a suitable level.
- Step 3** ➤ Press **▲** or **▼** to adjust electrical focus for best overall sharpness.

- Step 4** ➤ Press  or  to adjust skew until the vertical line through the center of the image is not tilted (perpendicular to the horizontal line). Press  or  until the center horizontal line is perpendicular to the vertical.



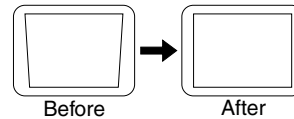



- Step 5** ➤ Press  or  to adjust keystone until the width at the top of the picture is equal to the width at the bottom.

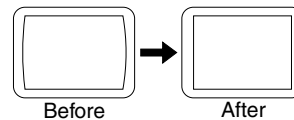





- Step 6** ➤ Press  or  to adjust side pincushion until the left and right sides of the picture are straight and not curved.

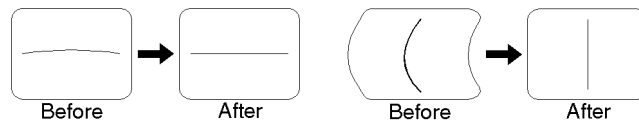





- Step 7** ➤ Press  or  to adjust vertical bow until the horizontal line at the middle of the picture is straight. Press  or  to adjust horizontal bow so that the vertical line at the middle of the picture is straight.

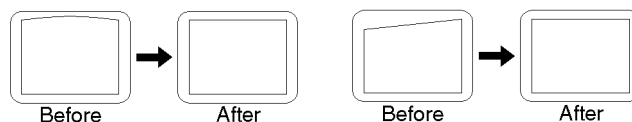



- Step 8** ➤ Press  or  to adjust top pincushion until the horizontal line at the top of the picture is straight and not curved. Press  or  to adjust top keystone so that the top edge is level.



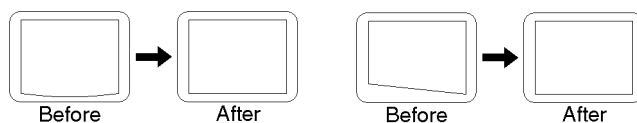

- Step 9** ➤ Press  or  to adjust bottom pincushion until the horizontal line at the bottom of the picture is straight and not curved. Press  or  to adjust bottom keystone so that the bottom edge is level.



Step 10 ➤ Adjust C linearity as follows:

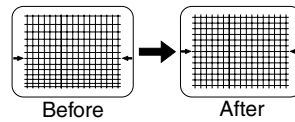

Press  or  until the horizontal line through the center of the crosshatch is equally distant from the lines at the very top and bottom.



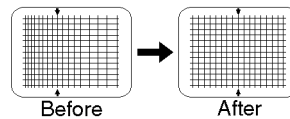

Press  or  until the center of the crosshatch is equally distant from the vertical lines at the left and right edges.



Step 11 ➤ Adjust S linearity as follows:

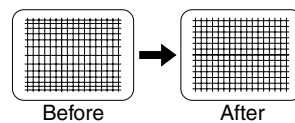



Press  or  until the height of each crosshatch square is equal from the top to the bottom.

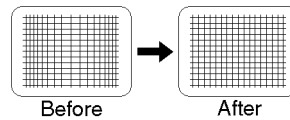





Press  or  until the width of each crosshatch square is equal from the left to the right.

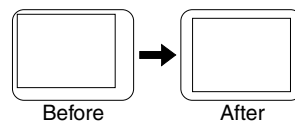

The source connected to the currently selected input should now be visible. If there is no picture, check to see if the source is active.

Step 12 ➤ Press , ,  or  to adjust phase until the picture is centered on the screen.



Step 13 ➤ Press , ,  or  to adjust the size of the picture. Ensure that objects in your picture have the correct shape. For example, if there is a circle in your picture, size should be adjusted until the circle is round, not oval.

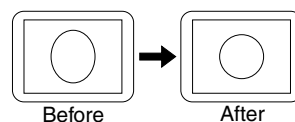

Step 14 ➤ The final step is convergence. If the projector includes the ACON option, press **EXIT** **CONV** **4** to exit the guide and allow ACON to converge the system. Otherwise, press **EXIT** **CONV** **1** to enter Guided Convergence.

Reminder: Remember that all of the adjustments above should be repeated for other sources in the system.

2.10 Memory Setup

This section explains how to set up projector memories to improve the performance of the projector's ASI and ASR features. If you are not familiar with setup memories, read section 3, *Operation*, prior to memory setup; in particular, read section 3.4, *Setup Memories*, and the *ASI with Save* and *Turn ASR On/Off* entries in section 3.7, *Utility Features*. If the projector's setup memories are properly set up, the projector will be easier to use and operate.

Note: Memory setup should be performed when the projector is in its final operating position. If the physical position of the projector changes, memory setup must be repeated.

Here is a brief summary of the setup memory, ASR, and ASI discussions in Section 3.

About Setup Memories ...

The projector has 75 setup memories for storing display settings of different sources. Multiple setup memories are required since display settings usually vary amongst sources. There are two types of setup memories: Input and Recall. Both memory types store the same parameters. The only difference is that Input memories store display settings for a particular physical input (e.g., switcher 0, slot 1) while Recall memories can be used with any input.

At any one time, one setup memory is the current setup memory. The display settings in the current setup memory are used for the current display. When a source is selected by entering its input number, the Input memory for the selected input becomes the current setup memory*. If a Recall memory is selected, it becomes the current setup memory*. Display adjustments are automatically saved in the setup memory which is current at the time of adjustment (unless the setup memory is locked).

** Note: If the ASR feature (explained below) is turned on during setup memory selection, the selected memory may not be the current setup memory.*

To display the Recall memories stored in the projector, press **UTIL** **3**. Press **UTIL** **4** to display the Input memories. (Unused setup memories are not displayed).

About ASI and ASR ...

ASI (Automatic Source Interpolation) is a feature which automatically adjusts display settings based on the settings of other setup memories stored in the projector. When a setup memory is first created, ASI automatically generates its initial display settings. These settings will be created by copying another setup memory or by interpolating multiple setup memories.

ASI is activated when:

- A new setup memory is created.
- An ASR is performed and its logic has activated an ASI.
- An “ASI with Save” is specified by the user (see section 3.7).

ASR (Automatic Source Recall) is a feature which, when turned on for a given input, provides automatic Recall memory selection or ASI adjustment. ASR processing can activate when: 1) a change in scan frequencies is detected at the input, 2) an input is selected, 3) a Recall memory is selected, or 4) a channel is selected. This feature is primarily intended for use when many different sources must share the same input (via a third party switcher, for example) or when a signal source can output several different scan frequencies (e.g., a SVGA card). When a source switch is made, the projector may automatically select a Recall memory with matching scan frequencies or create the display settings based on the settings in other setup memories. (Refer to Appendix C for ASI/ASR logic diagrams.)

Input Memory ► Setup

Follow these steps to prepare an Input memory for a source.

Note: To assure proper setup of an existing Input memory, ASR must be off (default) for the memory.

Step 1

Connect the source to the input to be set up, then select the input using the Source command. For example, if the source is connected to slot 1 of the projector, press **SOURCE** **0** **1**. If the Input memory did not previously exist, it will be created automatically.

Step 2

The source should be displayed on the projection screen. If much adjustment is required, press **UTIL** **0** **2** to perform an *ASI with Save*. The display appearance may improve based on the settings stored in other setup memories. (If the Input memory is new, *ASI with Save* will have already been performed when the input was selected.)

Step 3

Make display adjustments as required. Adjustment changes will automatically be saved in the Input memory.

Recall Memory Setup ➤

Follow these steps to prepare a Recall memory.

Step 1

Select the input connected to the source. For example, if the source is connected to switcher 1, slot 5, press **SOURCE** **1** **5**. The source should be displayed on the projection screen.

Note: To assure proper setup of a Recall memory, ASR must be off (default) for the current input.

Step 2

Select a Recall memory as the current setup memory. For example, to make Recall memory 03 the current setup memory, press **RECALL** **0** **3**. If the Recall memory did not previously exist, it will be created automatically.

Step 3

If much adjustment is required, press **UTIL** **0** **2** to perform an “ASI with Save”. (If the Recall memory is new, ASI with Save will have already been performed when the memory was selected.)

Step 4

Make display adjustments as required. Adjustment changes will automatically be saved in the Recall memory.

ASI Improvement ➤

If the projector will be used with many sources, or new sources will be frequently added to the system, it is recommended that five or six setup memories be created expressly for the purpose of improving ASI accuracy. ASI accuracy improves as more setup memories are created and stored, and the variations amongst horizontal and vertical scan frequencies increases. For example, if you always use the same input and you never use Recall memories (thus only one setup memory has ever been created), ASI will not be effective. However, if many Input and Recall memories have been used and adjusted for a variety of sources, the projector has more “knowledge” in its database for performing an ASI. As this “knowledge” increases, ASI accuracy improves.

An easy way to add setup memories at various scan frequencies is to use the projector’s internal frequency generator. The internal frequency generator can display a test pattern using the scan frequencies you select. When display adjustments are made, the display settings are stored in the current setup memory. Prepare a Recall memory using the generator as follows:

Step 1

Select a Recall memory to be the current setup memory. For example, to make Recall memory 90 the current setup memory, press **RECALL** **9** **0**. (Recall memory numbers may be any number from 01 to 99). If the selected Recall memory did not previously exist, it will be created automatically.

Step 2

Press **UTIL** **1** **6** to access the Internal Frequency Selection menu. Items one to six contain preset scan frequencies covering the scan range of the projector. It is recommended that Recall memories be created for each. To make a selection, enter an item number or use **▲** and **▼** to move the cursor bar to the item you want, then press **ENTER**.

	Horiz	Vert
1.	15.73	59.94
2.	31.47	59.94
3.	47.71	71.90
4.	62.50	66.67
5.	89.30	70.00
6.	126.84	60.00

Tip: It is recommended that Recall memories for the two extreme frequencies be set up first (items 1 and 4). When other Recall memories are created, their initial display settings will be based on the settings already stored in memory.

Step 3

At this point, a test pattern is displayed. Make display adjustments as required. All display settings will be stored in the Recall memory. To create another Recall memory, repeat the above steps. To return to the external source, press **EXIT** while only the test pattern is displayed.

(You may notice that as new Recall memories are created, fewer display adjustments are required. This is because ASI is using other setup memories to create the initial settings of the new memories.)

ASR Setup ➤ This subsection provides two examples of how the ASR feature may be used and set up.

ASR Example #1

Refer to the system illustrated in Figure 2-23. A computer is connected to slot 1 of the projector as shown. The graphics adapter in the computer can operate at different frequency modes to accommodate various software applications. The ASR feature may be used until when the frequency mode of the computer changes, the projector setup also changes to match that of the new mode.

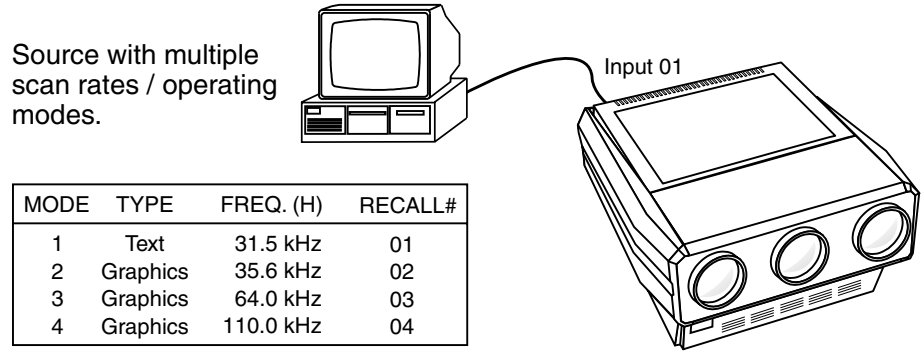

Figure 2-23. ASR System Example #1

To prepare setup memories for the above system, follow these steps:

Step 1

Select the input using the Source command. Press **SOURCE** **0** **1** to select projector slot 1.

Step 2

Press ***** twice to display the Current Input Parameters status page. Check to see if ASR is off for the current input. If it is on, press **UTIL** **1** **4** to turn ASR off for the input. (It is usually easier to prepare setup memories when ASR is turned off.)

Step 3

At the computer, switch to an application which uses one of the graphics adapter operating modes. Select an unused Recall memory as the current setup memory. For example, to make Recall memory 01 the current setup memory, press **RECALL** **0** **1**. Make display adjustments as required. The display settings for the current graphics mode will be stored in the Recall memory. Repeat this step for the remaining graphics adapter operating modes, storing adjustments for them in Recall memories 02, 03 and 04. It is recommended that the two extreme frequencies be set up first.

Step 4

Press **SOURCE** **0** **1** to make Input memory 01 the current setup memory then press **UTIL** **1** **5** to display the Clear Setup dialog box. Move the cursor to “Do It” then press **ENTER** to clear the display and frequency settings of the input. Now Input memory 01 will not be used during an ASR search.

Step 5

Press **UTIL** **1** **3** to lock Input memory 01 to prevent display or frequency changes to the Input memory.

Step 6

Press **UTIL** **1** **4** to turn ASR on for the input. Now, each time the computer's graphics adapter switches operating modes, the projector will automatically adjust its display settings to suit the new mode.

ASR Example #2

Refer to the system illustrated in Figure 2-24 below. Six different sources are connected to a third party (non-Madriral Imaging) signal switcher. Under normal circumstances, the projector is not aware of source switches made by the switcher. However, if ASR is turned on for the input, and a Recall memory has been set up for each source device, the projector will detect the external source switch and automatically select the appropriate Recall memory. Even if Recall memories have not been set up but ASR is on, ASR will try to adjust the display settings based on the settings of other Input or Recall memories.

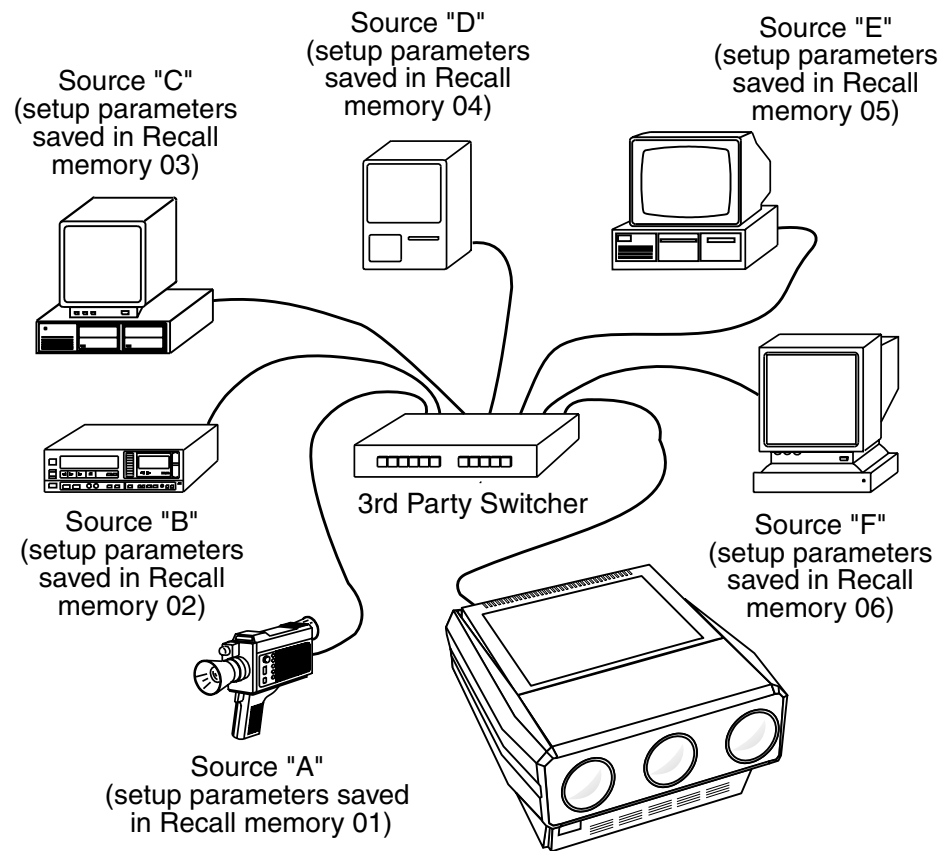

Figure 2-24. ASR System Example #2

To prepare setup memories for this system, follow these steps:

Step 1

Connect the output of the signal switcher to a projector input. Select the input using the Source command. For this example, press **SOURCE** **0** **1** to select projector slot 1.

Step 2

Press **[F3]** twice to display the Current Input Parameters status page. Check to see if ASR is off for the current input. If it is on, press **[EXIT]** then press **[UTIL]** **[1]** **[4]** to turn ASR off for the input.

Step 3

At the switcher, switch in one of the source devices. Select an unused Recall memory as the current setup memory. For example, to make Recall memory 01 the current setup memory, press **[RECALL]** **[0]** **[1]**. Make display adjustments as required. The display settings for the selected device will be stored in the Recall memory. Repeat this step for the remaining devices.

Step 4

Press **[UTIL]** **[1]** **[5]** to display the Clear Setup dialog box. Move the cursor to “Do It” then press **[ENTER]** to clear the display settings and frequency settings of the input. By doing this, Input memory 01 will not be used during an ASR search.

Step 5

Press **[UTIL]** **[1]** **[3]** to lock Input memory 01 to prevent display or frequency changes to the Input memory.

Step 6

Press **[UTIL]** **[1]** **[4]** to turn ASR on for the input. The projector’s display settings will automatically adjust to match the source selected by the switcher.

2.11 ACON Setup



This section provides setup and usage guidelines for systems which include the ACON automatic convergence feature.

There are a few simple rules and operation fundamentals which should be understood and considered when installing a projector which includes the ACON automatic convergence feature. ACON operates on the principle of monitoring projected screen images via its Locator Assembly, analyzing this data, then adjusting the vertical and horizontal positions of the red and blue colors until optimum convergence with the green is achieved. This process requires that the view of the display screen by the Locator Assembly be totally unobstructed. ACON’s performance can be adversely affected if the projector’s optical and system functions are not properly set. Ensure the projector is focused and all user adjustments have been made prior to operating ACON.

Figure 2-29 illustrates two common projection system configurations. ACON responds differently for each configuration. The projector configuration is determined by ACON during the Learn Screen process. Always perform a Learn Screen for a new or changed installation. For more information on Learn Screen, refer to section 3.6, Convergence Registration.

If the installation is rear screen, the Locator Assembly should be mounted in front of the display with an optional Locator Mounting Bracket (kit# 38-8000805-01). See Figure 2-30.

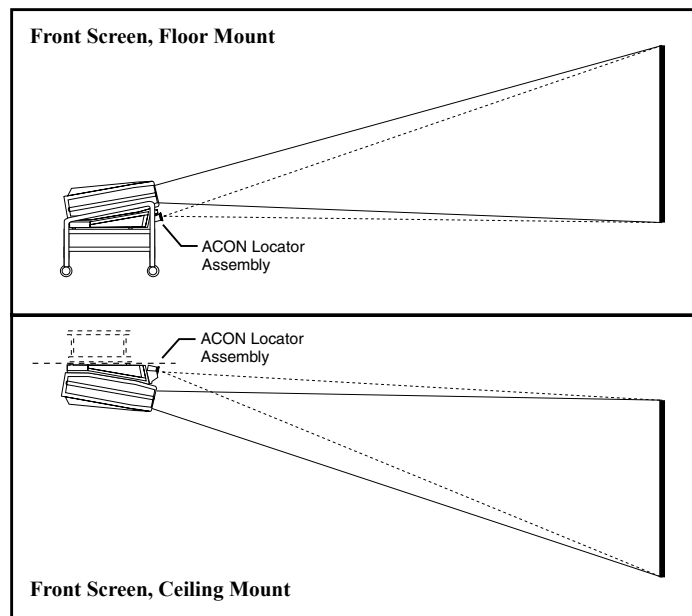

Figure 2-29. ACON Installation Examples

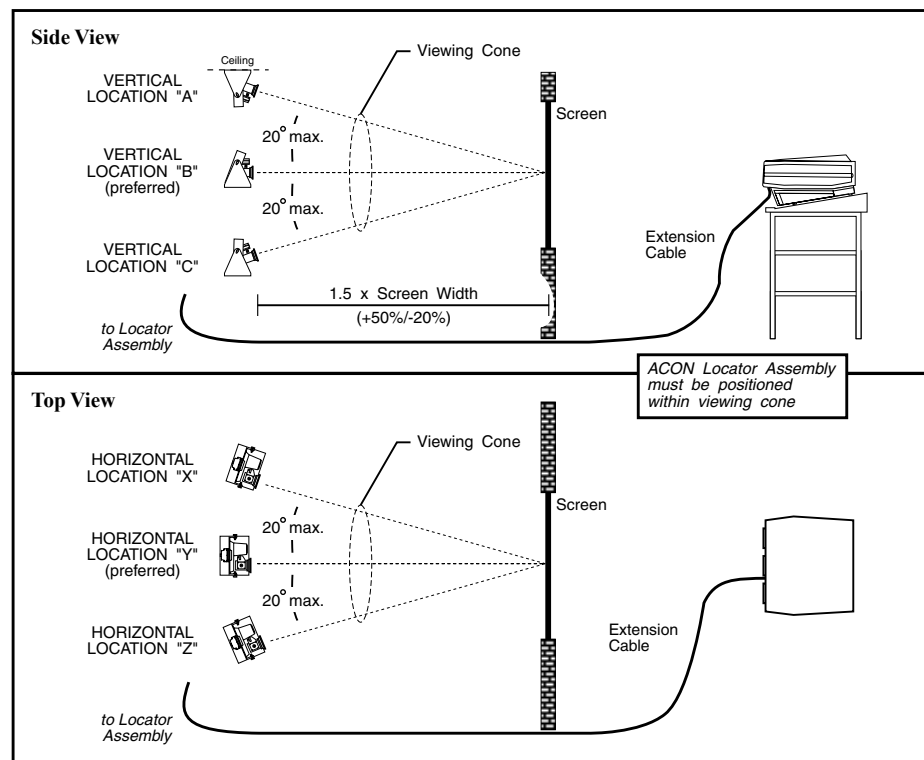

Figure 2-30. Remote Locator Assembly Placement

Operation

3.1 Overview

This section explains how to operate the projector once it has been installed and is ready for use. If you have not yet set up the projector, refer to Section 2, *Installation and Setup*.

Before using the projector for the first time, it is recommended that you read through this section of the manual. Although the projector is easy to use, there are many advanced features which allow you to enhance performance and operation. By understanding these features, and how to use them, you will soon be able to take full advantage of the projector's extensive capabilities.

Organization of this section is as follows:

- 3.1 Overview
- 3.2 Projector Basics
- 3.3 Source Selection
- 3.4 Setup Memories
- 3.5 Display Adjustments
- 3.6 Convergence Registration
- 3.7 Utility Features
- 3.8 Multi-projector Functions

3.2 Projector Basics

Notice that the projector has no knobs or moving parts to make adjustments or change control settings. This is because all user adjustments are digitally controlled via the projector's keypad. Adjustment settings are retained in the projector's internal memory, even when the projector is unplugged.

Keypads ►

Four types of keypads may be used with the projector: built-in, IR remote, wired remote, and touch-screen. The projector includes a multi-use, full function, backlit keypad which is factory configured for use as a built-in keypad. It can easily be reconfigured for use as an IR remote keypad or a wired remote keypad. A Madrigal IRIQ programmable touch-screen remote is also included for overall system control. Use the keypad type which is most appropriate for your application.

Notes: 1) For information on how to reconfigure the keypad, refer to section 2.3, Hardware Setup. 2) To convert the keypad to a wired remote keypad, an optional accessory cable (#03-001106-02P) is required. 3) Additional keypads are available from your dealer and Madrigal.

Built-in Keypad

When the keypad is configured for built-in use (factory default), it is connected to the projector by a 3 foot extension cable, located below the front top cover. This configuration is intended for initial setup of the projector and applications where it is desirable to keep the keypad with the projector.

The keypad can be accessed as follows:

Locate the front top cover of the projector. Position your hands above the red and blue lenses then grasp the cover. Lift the cover until the keypad is exposed. Slide the cover away from the projector. The keypad is mounted to a securing bracket located above the lens assemblies as shown in Figure 3-1.

The built-in keypad can slide out of its securing bracket but it is recommended that it remain in place for use. When finished using the keypad, position the front top cover back in place.

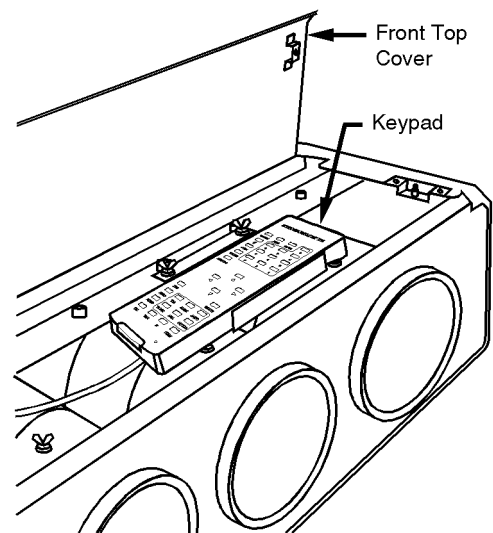

Figure 3-1. *Built-in Keypad Access*

IR Remote Keypad

When the keypad is configured for IR remote operation, you can control the projector from a distance without a wired connection to the projector. The keypad includes a battery powered infrared (IR) transmitter.

Wired Remote Keypad

When the keypad is configured as a wired remote keypad, you can control the projector from a distance by way of a 25 ft extension cable (accessory cable required). Wired remote keypad operation is recommended when:

- the location of the keypad with respect to the projector or screen is inadequate for IR remote keypad operation,
- the projector is in a lighting environment which is unsuitable for IR remote keypad operation, or
- there are multiple projectors in the same room and you want each projector to be controlled by its own remote keypad.

Figure 3-2 shows the projector functions which are accessible from the multi-use (full function) keypad. As you may notice from the figure, some keys provide direct access to specific functions (such as **POWER** to turn the projector on or off), and some keys provide indirect function access via menus. Functions which are less frequently accessed are provided through on-screen menus.

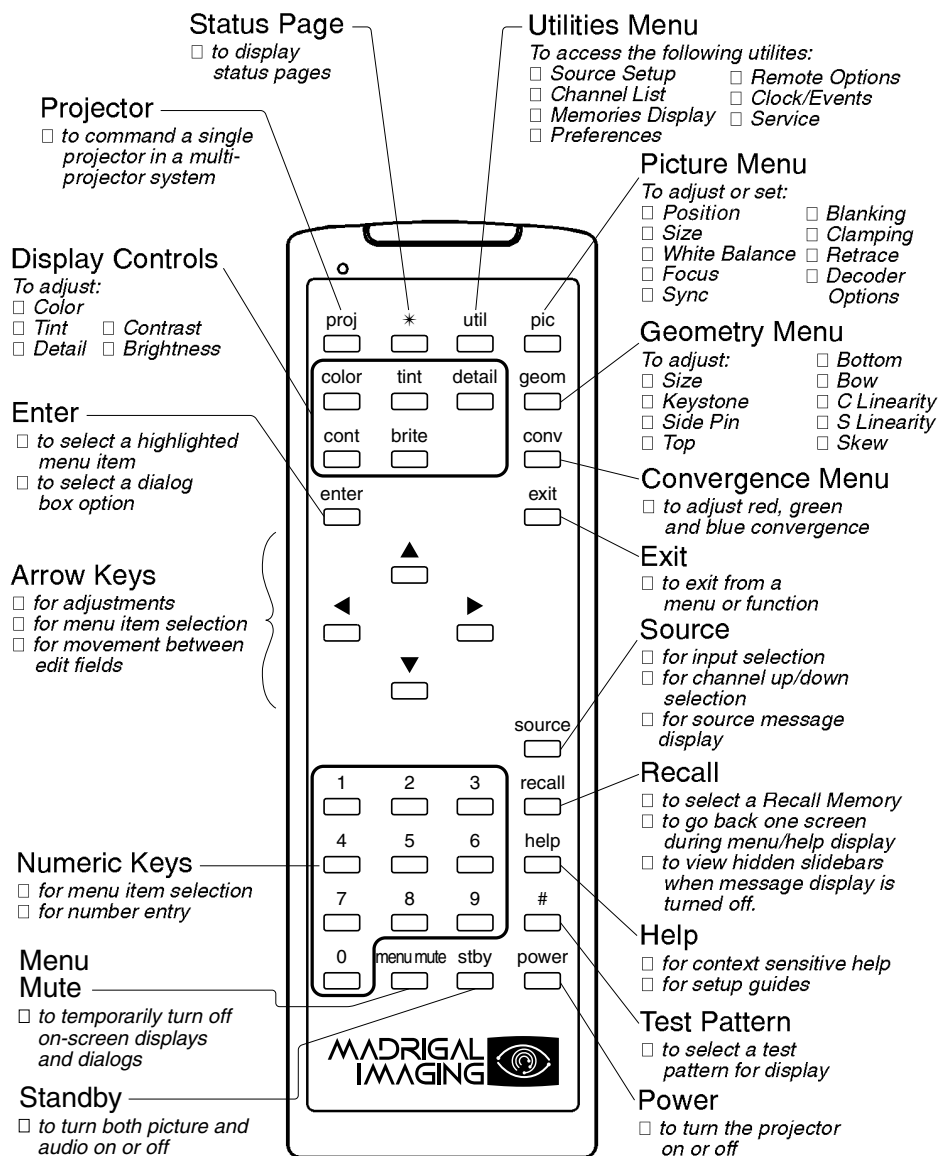

Figure 3-2. Full Function Keypad

Keypad Usage ➤ The keypad is used the same way you would use a remote keypad supplied with a TV or VCR. There are only a few general key press rules to keep in mind:



Key Press Rules

- 1) All key presses are in sequence; no functions require simultaneous key presses.
- 2) **POWER** and **STBY** are the only keys which require an extended hold-down for function activation (about one second). For all other keys, a momentary press will activate the key's function.
- 3) **▲**, **▼**, **◀** and **▶** are the only keys which repeat when held down. For all other keys, the key must first be released then pressed again for repeated activation.
- 4) Pressing **EXIT** always exits the current function, operation, menu, or dialog box.

*Notes: 1) To toggle the keypad's backlit display (enable or disable), press **☒** **BRITE** **TINT** **DETAIL** **☒**. See section 2.3 for details. 2) If keys are pressed at a time when the projector is busy (such as during power-up), the key presses may not take effect.*

When the projector is turned on, it begins operation at Operation Level. Operation level is the normal level of operation at which a source image is (or may be) displayed. The projector temporarily leaves operation level when menus are displayed, control settings are changed, or online help is accessed. The screen display changes to reflect the operation or function being performed. One or more of the following may be displayed:

- Slidebar - to make adjustments to display settings.
- Menu - to select projector functions or change projector settings.
- Dialog Box - to select an action such as confirm or cancel an operation.
- Message Box - to display messages.
- Help Page - to display help and provide assistance.
- Test Pattern - to assist during setup.

(Note: The display of slidebars and messages can be suppressed if desired. For more information, refer to section 3.7, Utility Features).

Each of the above are explained in the following entries. As you read through the explanations, note the following:



In most cases ...

- EXIT** brings you back to operation level,
- RECALL** brings you back to the previous page or menu,
- ENTER** is pressed to make a selection, and
- HELP** provides context-sensitive help.

Slidebars

When an adjustment is made, a sidebar is superimposed on the projection screen. The sidebar displays the adjustment setting on a percentage scale. To make an adjustment, use the arrow keys indicated by the sidebar. Press **EXIT** to end an adjustment or, for a sidebar accessed from a menu, press **ENTER**. If no keys are pressed within 5 seconds while a sidebar is displayed, the sidebar disappears.

For example, if **CONT** is pressed, the Contrast sidebar is superimposed on the image. The sidebar shows that contrast is set to 50%. Press **▲** or **▼** on the keypad to change the contrast level. When complete, press **EXIT**.

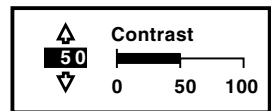

Menus

When a menu key is pressed or a menu is selected, a menu with a list of selection items is superimposed on the projection screen. Each menu consists of a title, selection items, and a cursor bar. Selection items may include adjustment functions, control settings or other menus.

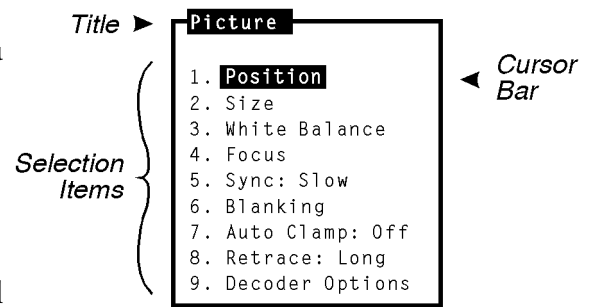

To make a selection from the menu, either:

- press the number key corresponding to the item number, or
- press **▲** or **▼** to move the cursor bar to the desired item, then press **ENTER**.

If a menu item includes control options, for example, items 5, 7 and 8 above, the control option setting can be changed by pressing the number key or by pressing **ENTER** when the item is highlighted.

*Note: Pressing **RECALL** while in a sub-menu returns you to the previous menu.*

Dialog Boxes

Dialog boxes are displayed when the projector requires an action to be chosen by the user.

For example, after a convergence registration is performed, a dialog box is displayed to confirm that the new convergence settings are to be saved in memory. Press **▲** or **▼** to highlight one of the actions then press **ENTER** or **EXIT** to perform the action. If **ENTER** is pressed, the previous menu is then displayed. If **EXIT** is pressed, the projector returns to operation level.

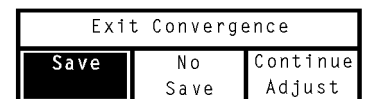

Message Boxes

Message boxes display brief messages on the screen to indicate a status, condition, or error. Messages are overlaid on the displayed source image and in most cases remain on the screen for about five seconds. To remove a message box prior to the five second display period, press **[EXIT]**.

Help Pages

Help pages provide assistance when you need it. There are various forms of help available, all accessible by pressing **[HELP]**. For information about using help, refer to the *Using Help* entry in this section.

To advance one page when using help, press **[HELP]**. To go back one help page, press **[RECALL]**. To exit from a help page, press **[EXIT]**.

Test Patterns

The projector has an internal generator which can display several different types of test patterns to assist you during projector setup. Press **[#]** to display the first test pattern — a crosshatch. Each subsequent press of **[#]** changes the test pattern as shown below. If a test pattern is the only graphic displayed (i.e., no overlaid text), pressing **[EXIT]** returns the display to the external image.

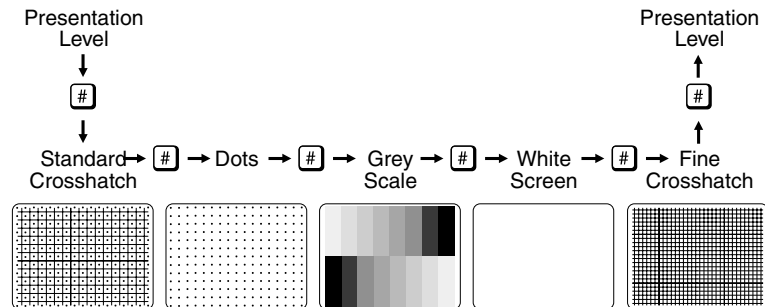

Note: Test patterns are normally generated at the scan frequencies of the current input signal.

Using Help ➤

The projector includes an extensive online help system. The help system provides operation guidance and assistance. There are two types of online help: Context Sensitive Help and Guided Help.

Context Sensitive Help

Context Sensitive Help provides help on how to use a specific function.



To view help pertaining to a dedicated key function, press the key then press **[HELP]**. For example, to view a help page which describes how to use the brightness function, press **[BRITE]** **[HELP]**.



To view help pertaining to a menu selectable function select the function then press **[HELP]**.



To view help describing a menu, press **HELP** while the menu is displayed.

If multiple pages are available, press **HELP** to advance to the next page. Press **RECALL** to go back to the previous page. To end help, press **EXIT**.

Guided Help

Guided Help provides several online tutorials which explain how to operate the projector and assist you during installation and setup.



To access the tutorials, press **HELP** at operation level. The Help menu is displayed. When using tutorials, press **HELP** to display the next tutorial page, press **RECALL** to display the previous page, press **EXIT** to end help.

HELP

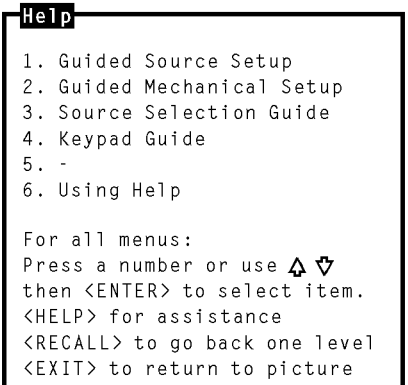

1. Guided Source Setup

The Guided Source Setup tutorial provides step-by-step instructions for quick setup of the projector with the currently selected external source. Setup may be performed while proceeding through the tutorial.

*Notes: 1) During the tutorial, **RECALL** displays the previous page and **EXIT** returns you to operation level (this includes when slidebars are displayed). 2) If the display cannot be focused, ensure that the throw distance is correct (see section 2.2). If the screen distance is correct but the display cannot be focused, follow the Guided Mechanical Setup tutorial.*

2. Guided Mechanical Setup

The Guided Mechanical Setup tutorial provides step-by-step instructions for mechanical and optical setup of the projector. This setup is necessary during initial installation and also when the screen size changes, the throw distance changes, or the display image does not focus using the focus control. For more details, refer to section 2.8, *Optical Alignment*.

3. Source Selection Guide

The Source Selection Guide explains various source selection methods.

4. Keypad Guide

The Keypad Guide explains how to use the keypad.

6. Using Help

Using Help provides instructions on how to use the help system.

Power-on ➤ To turn on the projector, press **POWER** on the keypad. Hold **POWER** down for about one second. If using an IR remote keypad, point the keypad at the projection screen or the front of the projector. During power-on, the projector proceeds through a series of internal diagnostic tests that last approximately 9 seconds. Once complete, an input image should be displayed on the projection screen. If no image is displayed, press **SOURCE** to display the source message. The source message displays the currently selected input. Check that the correct source is indicated on the display.

If there is no display when **⏻** is pressed, check the LEDs (Light Emitting Diodes) on the projector back panel. Only the green **POWER** LED should be lit. If any of the red diagnostics LEDs are lit, call your dealer for assistance.

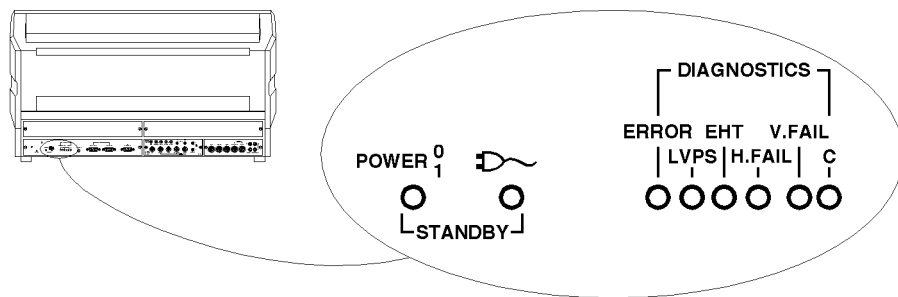

Figure 3-3. Rear Panel LEDs

Notes: 1) Allow the projector to warm up for 45 minutes before use. Critical adjustments should be performed after the warm-up period. 2) Turning the projector off via a remote or built-in keypad places the projector in a “wait to operate” mode. To remove power from the projector, unplug the power cord.

Standby Mode ➤ Standby Mode allows you to blank the display and mute the audio output while keeping the projector in a warmed-up and ready state.



To enter standby mode, hold down **STBY** for about one second while at presentation level. The display blanks and audio is muted. Both the green **POWER LED** and the yellow **STBY** LED are lit. To leave standby mode, hold down **STBY** or **EXIT** for one second. The display and audio are then restored and the **STBY** LED is turned off.

Tip: During presentations, the standby feature is useful when you want to direct audience attention away from the projection screen.

Note: To prolong CRT life, it is recommended that the standby feature be used when the display is not required.

Audio ► Mute Functions

The Mute function is used to silence audio output.



To silence the audio output, press **[MUTE]**. Press **[MUTE]** again to restore audio.

Volume

The Volume function is used to adjust the audio output level.



To adjust Volume, press **[VOL]** then **[▲]** or **[▼]** until the desired audio level is attained.

System Status ► Pages

The projector's current operating settings may be displayed by pressing **[*]** while at operation level. Each time **[*]** is pressed, one of three main status pages is displayed. To return to operation level, press **[EXIT]**.

Page 1 displays general projector information and operating settings which include identity, software version, date and time, keypad type, scan configuration, auto power-up setting, message display setting, switchers (numbers) connected, installed options, and mute setting. Operating settings are explained in the following entries in this section.

Page 2 displays current input parameters. These parameters (defined later in this section), relate specifically to the currently selected input.

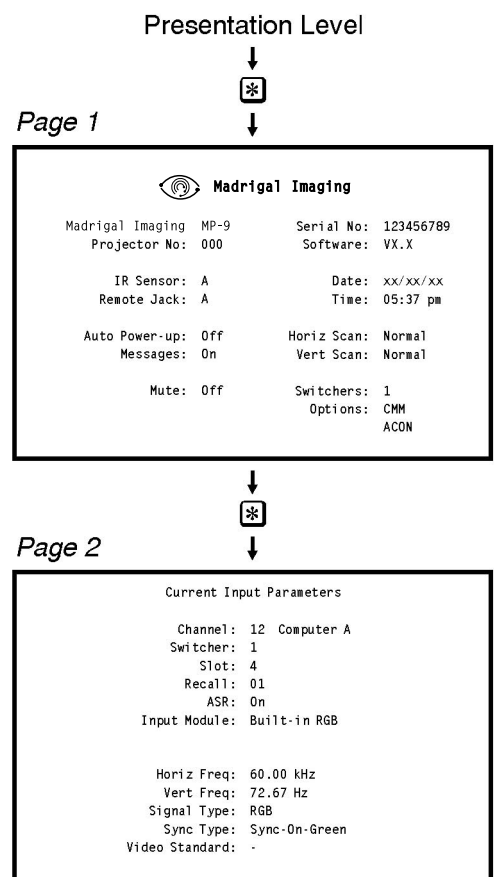

Page 3 lists the display settings currently in use. Note: If the current setup memory is locked or an ASI has occurred, the display settings shown may not be identical to those stored in the setup memory.

*Notes: To view help pages pertaining to the status pages and their contents, press **HELP** during status page display. "Time" does not update on-screen.*

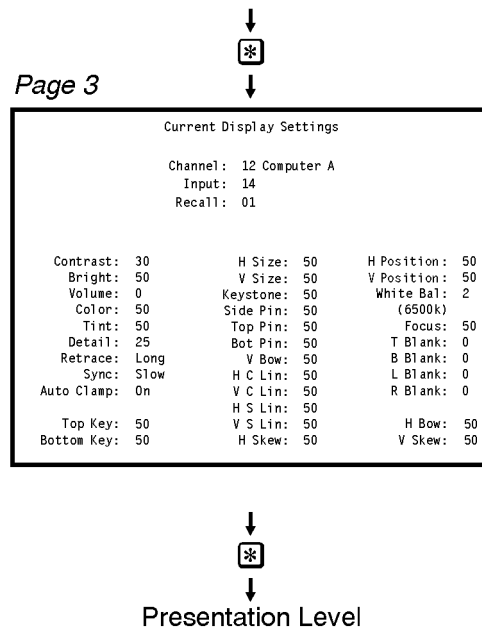

3.3 Source Selection

The projector includes a built-in RGB input interface to accept a single input. With optional accessories such as a Multi-standard Decoder, and the use of one or more external switchers, the number of inputs can be significantly increased. Because of this large capability, three source selection methods are available: Input Selection, Direct Channel Selection, and Up/Down Channel Selection. Sources are selected at operation level.

Notes: 1) For systems with only one or two source connections, direct input selection may be the only method you will use. If your system includes many sources, all methods will be of interest. 2) Internal sources are also selectable for use during setup and testing. To select an internal source, refer to section 2.10, Memory Setup, and section 3.7, Utility Features.

Input Selection ►

This method is the most basic of the three source selection methods. A source is selected by specifying the input to which the source is connected, defined by a switcher number and slot number. For the purposes of input selection, the projector is considered to be a type of switcher. Projector and switcher slots are illustrated in Figures 3-4 and 3-5 on the next page. Each slot can accept one external input signal for display.

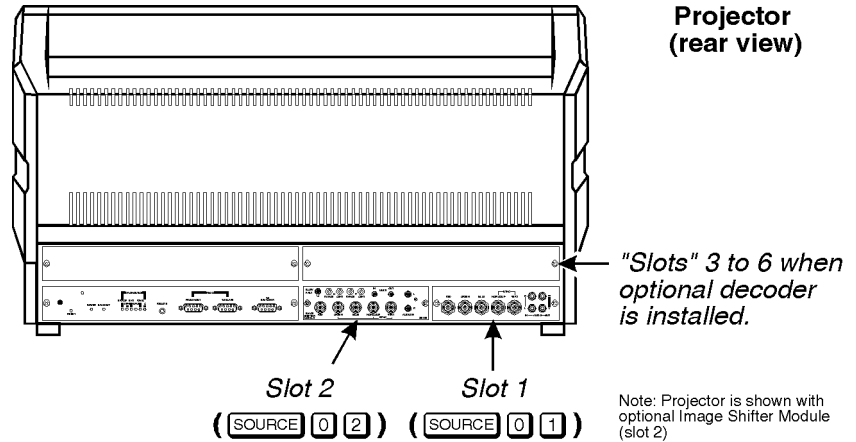

Figure 3-4. Projector Slots

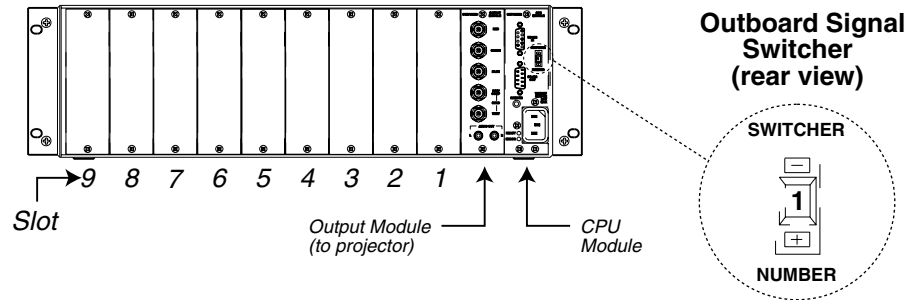

Figure 3-5. Switcher Slots



To select an input:

Press **SOURCE** **m** **n** at operation level.

where: $m = 0$ (projector) or 1-9 (switcher 1, 2, ... 9)
 $n = 1-9$ (slot number)

The projector switches to, and displays, the source connected to the input selected. The projector also uses the display settings previously set in memory for that input. If the selected input is invalid, a warning message is displayed. An example of an invalid input might be "0 1" when a switcher is connected to slot 1 of the projector. Another example of an invalid input would be to select a switcher which does not physically exist.

Example 1

Slot 1 on the projector has the output from a computer workstation connected to it. To display the workstation output, press **SOURCE** **0** **1**.

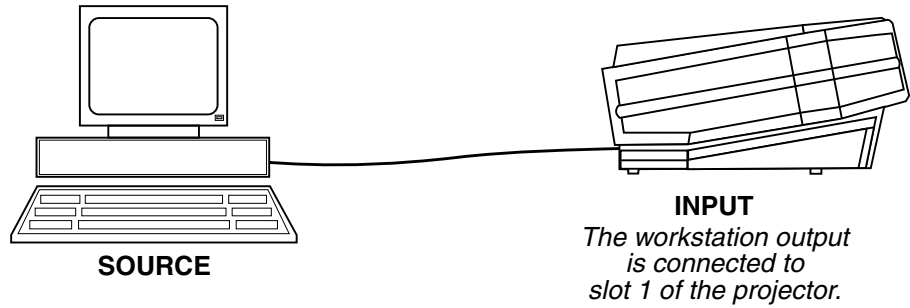

Example 2

A single signal switcher is connected to the projector and a computer is connected to slot 3 of the switcher. To display the computer output, press **SOURCE** **1** **3**.

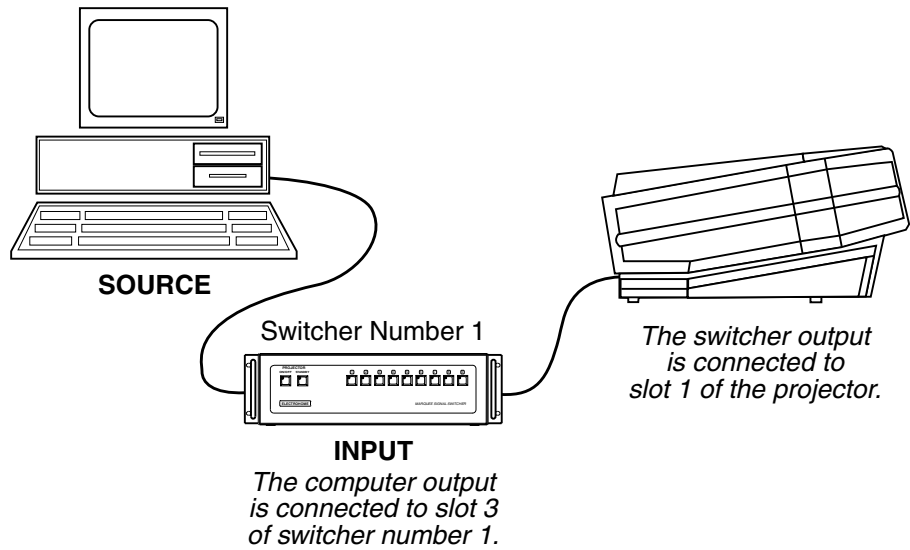

Note: If a switcher is connected to the projector, its inputs can be selected using the switcher's front panel push buttons.

Direct Channel Selection ➤

This method of source selection takes advantage of the Channel List feature explained in section 3.7, *Utility Features*. The Channel List allows you to assign a source to a 2-digit number, from 01 to 99.

Once you have assigned channel numbers to your sources, and the projector is at operation level, you can select a source by pressing the 2-digit channel number associated with it.



To select a channel, press **m** **n**.

where: m = the 1st digit of the channel number
 n = the 2nd digit of the channel number

The projector switches to, and displays, the source assigned to the channel number. If an invalid switcher or slot number is assigned to the channel, a warning message is displayed.

Example

Channel 08 in the Channel List was programmed to select a source connected to slot 5 on switcher 3. To select this source, simply press **0** **8**.

*Note: If the Channel Select option in the Preferences menu (**UTIL** **5** **4**) is set to either “1 digit only “ or “1 or 2 Digits”, the preceding zero shown in the example above does not have to be entered. For more information, refer to the Preferences entry in Section 3.7.*

Up/Down Channel Selection ▶

This method of source selection also takes advantage of the Channel List feature. It lets you quickly switch between channels programmed in the Channel List by using the up and down arrow keys on the keypad.



To make a selection:

Press **SOURCE** followed by **▲** or **▼**.

Each time an arrow key is pressed, a channel number (and name) is displayed on the screen. When the channel number you want is displayed, simply wait to allow the projector to switch to the source defined by the channel.

Notes: 1) If a channel specifies a switcher which does not exist, the channel is considered invalid. 2) The Channel List utility allows you to flag the channels to be used by the Up/Down Channel selection feature. For more information, refer to the Channel List entry in section 3.7, Utility Features.

The Source Message ▶

When **SOURCE** or **RECALL** is pressed at operation level, and/or a source switch is made, a source message is briefly overlaid on the projection screen. The source message displays current source information.

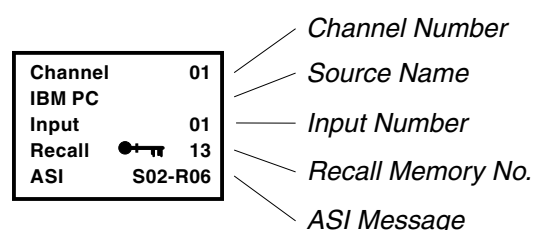

*Notes: 1) If screen messages are turned off via the Preferences menu (**UTIL** **5** **2**), the source message is not displayed. 2) During input selection or Recall memory selection (explained later), the message box displays numeric keypad entries as they occur. In both cases, two digits must be entered. If only one digit is entered, the message box will remain displayed until a second digit is entered or the selection is cancelled by pressing **EXIT**. 3) When an internal source is in use, an internal source message is displayed.*

Channel Number

If a channel has been selected, the channel number is displayed; otherwise this line is blank.

Source Name

If a channel was selected and a source name was defined for it in the Channel List, the name is displayed here; otherwise this line is blank.

Input Number

The switcher and slot number of the active input is displayed. If the switcher number is 0, the input is on the projector (versus on a switcher). The slot number may indicate a projector slot or a switcher slot.

If the Input memory for the input is in use and locked, a key icon () is displayed. Setup memories which are locked are not affected by adjustments to display settings. For an explanation of Input memories and locked memories, refer to section 3.4, *Setup Memories*.

Recall Memory Number

When a Recall memory is in use, the Recall memory number is displayed; otherwise this line is blank.

If the Recall memory is locked, a key icon () is displayed. Setup memories which are locked are not affected by display adjustment changes. For an explanation of Recall memories and locked memories, refer to section 3.4, *Setup Memories*.

ASI Message

If the ASR feature is set to ON for the Input memory, and an ASI has occurred, an ASI message is displayed; otherwise this line is blank. The message indicates which memories were used for interpolation to produce the current display settings. When this line is visible, adjustments to display settings will NOT be stored in the current setup memory. For more information about the ASR feature and ASI, refer to the Source Setup entry in section 3.7, *Utility Features*.

3.4 Setup Memories

The projector has 75 setup memories which store display settings. Multiple setup memories are needed because display settings are usually different for different sources. For example, the display settings (brightness, contrast, convergence, etc.) when using a VCR may be very different than the settings for a high resolution computer output. When display adjustments are made, the new settings are automatically saved in one of the projector's setup memories.

There are two types of setup memories: Input and Recall. Both memory types store the same parameters. The only difference is that Input memories store display settings for a particular physical input (e.g., switcher 0, slot 1) while Recall memories can be used with any input.

At any one time, one setup memory is the current setup memory. The display settings in the current setup memory are used for the current display. When a source is selected by entering its input number, the Input memory for the selected input becomes the current setup memory (unless ASR is on and is triggered). If a Recall memory is selected, it becomes the current setup memory. Display adjustments are automatically saved in the setup memory which is current at the time of adjustment (unless the setup memory is locked – explained later).

Input Memories ➤

As mentioned above, Input memories store display settings for each physical input (i.e., switcher 0, slot 1). When an input becomes the current setup memory, its display settings are used (unless ASR is on and is triggered). If the input is being selected for the first time, a new Input memory is created.

Recall Memories ➤

Recall memories provide an alternative to using the display settings stored in the Input memory of the selected source. For example, you may want to temporarily disconnect a computer connected to the projector's RGB input and in its place, connect another computer with different signal characteristics. Since the connection is only temporary you don't want to change the display settings stored in the Input memory. Instead, you can select a Recall memory which has the settings you want for the new input.

If there are many devices which will be sharing the same input, many Recall memories can be created to store the display settings for each. On the other hand, if there are many sources on different inputs with exactly the same signal characteristics, it may be possible for them to share the same Recall memory.

Recall memories are identified by a two digit number. Any number from 01 to 99 can be assigned, although only 75 memory spaces exist.

Setup Memory Parameters

Memory Identification

- Input or Recall*
- Switcher No. & Slot No., or Recall No.*

Memory Status

- Locked or Unlocked*
- ASR last used*

Signal Frequencies

- Horizontal Frequency*
- Vertical Frequency*

Picture Parameters

- Phase* *Focus*
- Size* *Sync*
- White Balance* *Blanking*

Primary Display Param.

- Color* *Contrast*
- Tint* *Brightness*
- Detail*

Geometry Parameters

- Size* *Bottom*
- Keystone* *Bow*
- Side Pin* *Linearity*
- Top* *Skew*

Convergence Parameters

- Convergence settings at all 45 zones.*

Control Settings

- ASR On/Off (Input memories)*
- Video Format (decoder only)*
- Signal Route*
- Volume (audio)*
- Clamping and Retrace*



To select or create a Recall memory:

Press **RECALL** **m** **n**.

where: m = the 1st digit of the Recall memory number
 n = the 2nd digit of the Recall memory number

For example, to select Recall memory 01, press **RECALL** **0** **1**. Recall memory 01 will then be the current setup memory and its settings will be used for the currently selected source. If this is the first time that the Recall memory number is used, a new Recall memory is created. Any display adjustments you make will be stored in the Recall memory.

Memory Allocation ➤

Each time a setup memory is selected the projector checks its memory bank to see if the selected memory exists. If it does exist, it uses the memory and its display settings. If it does not exist, a small portion of memory is allocated for the new setup. Space is available for up to 75 setup memories. When the last space is used up, a warning message is displayed. If this happens, call for servicing to delete memories which you no longer use to make room for new memories.

Locking Setup Memories ➤

Setup memories may be locked or unlocked. Locking a setup memory prevents adjustments to display settings from being saved in that memory. For example, if Recall memory 08 is locked and selected, then brightness is adjusted, the new brightness setting is only temporary. If the setup memory is then reselected, the original brightness setting will be restored.

Note: When a locked setup memory is selected, a key icon () is displayed in the Source Message.



To lock or unlock the current setup memory, select option 3 from the Source Setup menu (**UTIL** **3**). Option 3 indicates the current setting.

3.5 Display Adjustments

This section describes the projector's display adjustment functions. To access all display functions, a full function keypad is required. If you are using the IRIQ, only the primary display functions are available. There are four types of display adjustment functions: Primary, Picture, Geometry, and Convergence.

- Primary Display functions include Brightness, Contrast, Detail, Color and Tint. These functions are accessed directly from the keypad.
- Picture functions are used to adjust display settings that affect the projected image. These functions include Position, Size, White Balance, Focus, Sync, Blanking, Clamping, Retrace, and Decoding. Picture functions are accessed via the Picture menu which is selected by pressing **PICT** on the keypad.

- Geometry functions adjust geometric distortions of the display such as its size, keystone, pincushion, bow, linearity, and skew. Access Geometry functions via the Geometry menu – press **GEOM** on the keypad.
- Convergence is used to align the red, green, and blue color components of the image. It is described in section 3.6, *Convergence Registration*.

Most adjustment functions, when selected, display a sidebar overlaid on the source image. The sidebar displays the current setting and indicates which arrow keys to use for making the adjustment. Adjustment settings are stored in the current setup memory (Input or Recall). There are two exceptions: 1) If the current setup memory is locked, new adjustment settings are shown but not stored; they are discarded when another setup memory is selected. 2) If ASR is on for the current input and an ASI is performed, the settings are only temporary and are not saved in the current setup memory.

For new images, where much adjustment is required, it is recommended that adjustments be made using the sequence illustrated above. When making picture or geometry adjustments, follow the sequence displayed in the adjustment menu.

*Tip: When making many picture or geometry adjustments, press **ENTER** after each adjustment to return the cursor back to its previous menu item position.*

NORMAL ADJUSTMENT SEQUENCE

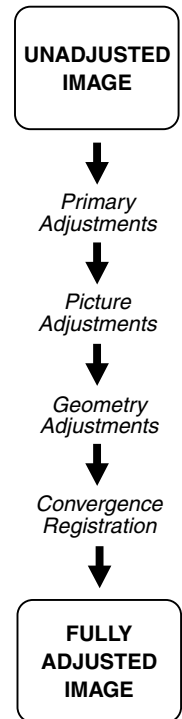

Primary Display ▶ Adjustments

Brightness

The Brightness function is used to adjust the black level of the image.



To adjust brightness, press **BRITE** then **▲** or **▼**. If video or data is displayed with a black background, adjust until the background just disappears (black becomes a very dark grey).

Note: If room lighting changes, it may be necessary to re-adjust brightness.

Contrast

The Contrast function is used to adjust the contrast between the light and dark areas of the display image.



To adjust contrast, press **CONT** then **▲** or **▼**. If contrast is set too high, the image loses detail and clarity. If set too low, it may be difficult to distinguish between foreground and background information.

Notes: 1) For best results, adjust brightness before contrast. 2) If room lighting changes, it may be necessary to re-adjust contrast and brightness. 3) An excessively high contrast level can reduce the life of the CRTs.

Detail

The Detail function is used to adjust the picture sharpness of video signals when using the optional Multi-standard Decoder. It has no effect on an RGB input.



To adjust detail, press **DETAIL** then **▲** or **▼** until the sharpest display is attained. Detail level should be roughly proportional to input signal quality. Higher levels of detail improve good quality signals. Lower levels of detail reduce noise in poor quality signals.

Color

1) The Color function is used to adjust color saturation levels when using the optional Multi-standard Decoder. It has no effect on an RGB input.



To adjust color, press **COLOR** then **▲** or **▼** until the desired color saturation level is displayed. If Color is set to a 0% level, the result will be a black and white picture. If Color is set too high, the color levels in the picture will be over-powering.

2) The Color function also allows you to turn on or off the red, green and/or blue color components of the picture.



Press **COLOR** followed by a number (*n*) to select the color components you want turned on. The chart shown here shows the selection variations.

<i>n</i>	COLORS TURNED ON	<i>n</i>	COLORS TURNED ON
1	red	5	green & blue
2	green	6	red & blue
3	blue	7	none
4	red & green	8	all

Tint

The Tint function is used to adjust color hue to obtain true color reproduction of NTSC signals when using the optional Multi-standard Decoder. It has no effect on an RGB input.



To adjust tint, press **TINT** then **▲** or **▼** until an optimum display is attained. It is best to adjust tint while displaying an image with natural flesh tones.

Note: Tint is not adjustable for PAL or SECAM video sources.



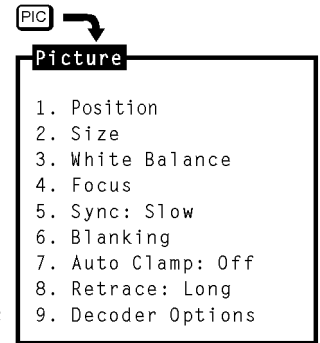

Picture Functions ➤

Picture functions are accessed through the Picture menu. To display this menu, press .

 1**Position**

The Position function is used to move the picture up, down, left, or right within the picture display area.







To adjust position, select Position from the Picture menu. Two slidebars are displayed: a Horizontal Position slidebar and a Vertical Position slidebar. Press , ,  or  to move the picture in the direction of the arrows so that the entire picture is visible and centered.

Note: If the picture cannot be made entirely visible, an adjustment to blanking or retrace time may be required; refer to the blanking and retrace entries in this section.

 2**Size**

The Size function is used to adjust the horizontal and vertical size of the display image. (This adjustment is also available through the Geometry menu.)





To adjust size, select Size from the Picture menu. Two slidebars are displayed: a Horizontal Size slidebar and a Vertical Size slidebar. Press  or  to adjust vertical size and  or  to adjust horizontal size until the objects within your picture have the proper shape. For example, if there is a circle in your picture, size should be adjusted so that the circle is round, not oval.

Note: The Size function should not be used to compensate for aspect ratio mismatches between source images and the projection screen. Not all sources use the same aspect ratio therefore it may not always be possible to fill the entire screen. ("Aspect Ratio" is defined in Appendix A).

 3**White Balance**

The White Balance function is used to select or adjust the color temperature (or shade) of white used by the projector. For most applications, the white balance setting set by the factory is satisfactory.



To select or adjust the white balance, select White Balance from the Picture menu. From the White Balance menu, select item 1, 2 or 3 to use a standard color temperature. Select option 4 to use the service adjusted user setting. Select option 5 to make a custom white balance adjustment. The current selection is indicated by a check mark. If option 5 is selected, a White Balance slidebar is displayed. Press  or  to adjust white balance.

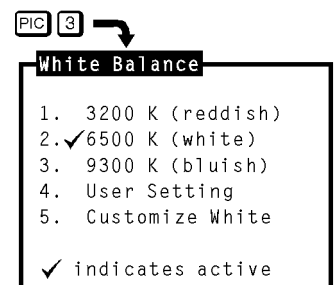

0% is 3200K, 50% is 6500K, and 100% is 9300K.



Focus

The Focus function is used to adjust the electrical focus of the combined red, green, and blue color components.



To adjust focus, select Focus from the Picture menu then use and until the center of the display appears the sharpest. If the displayed image cannot be adequately focused, a service adjustment to the electrical focus may be required or an optical focus adjustment is necessary. Refer to the section 2.8, *Optical Alignment* for optical focus instructions.



Sync (Fast/Slow)

The Sync function is used to minimize horizontal jittering, “flag waving” or tearing at the top of the display image. This effect sometimes occurs when the source is a VCR or video signal. The function changes the synchronization mode of the projector from fast to slow, or slow to fast.



To toggle between fast and slow sync, select item 5 from the Picture menu. Item 5 indicates the current synchronization mode.



Blanking (Top/Bottom/Left/Right)

The Blanking selection item is used to hide or blank out unwanted information or noise at the top, bottom, left, or right of the display image. Blanking adjustments may be required when the source is a VCR or video signal.



To adjust blanking, select Blanking from the Picture menu. From the Blanking menu, select item 1, 2, 3 or 4 to adjust the amount of blanking at the top, bottom, left, or right of the display (respectively). A blanking sidebar is displayed for each adjustment. A 0% level on the sidebar indicates no blanking. For top and bottom adjustments, use and to adjust the amount of blanking. For left and right adjustments, use and to adjust the amount of blanking. After completing each adjustment, press to return to the Blanking menu, or press to return to the picture.

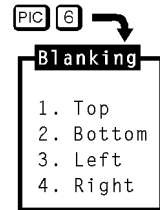

Auto Clamp (On/Off)

The Auto Clamp function is used to turn automatic signal clamping on or off. For most input signals, auto clamp should be on. However, if one or more of the red, green, or blue color components is abnormally bright, turn auto clamp off. An abnormally bright color component can occur if the input signal contains more than one sync type (e.g., both sync on green, and composite sync). If you are using a composite video source with ASR and are connected to an RGB interface, turn the Auto Clamp off.



To toggle auto clamp on or off, select item 7 from the Picture menu. Item 7 indicates the current Auto Clamp setting.

PIC 8 Retrace (Short/Long)

This function is used to set the projector's horizontal retrace time. Retrace time affects the width and display of the picture. A short retrace time may be required if information is missing or "cut off" at the left or right sides of the picture. A long retrace time may be desired if the picture is significantly smaller than the raster.



To toggle between short and long retrace, select item 8 from the Picture menu. Item 8 indicates the current retrace setting.

Notes: 1) Check phase, left blanking, and right blanking from the Picture menu before changing retrace time. 2) Long retrace is not available at all scan frequencies.

PIC 9 Decoder Options

The Decoder Options menu item allows you to control the operation of the optional Multi-standard Decoder.



To modify decoder operation, select Decoder Options from the Picture menu. From the Decoder Options menu, select item 1 to set the decoding method to use for the current source signal input to the decoder. Select item 2 to set the routing of the current source signal within the projector.

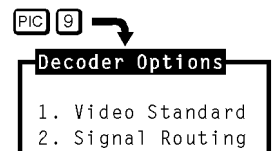

Video Standard

When item 1 is selected from the Decoder Options menu, the Video Standard menu is displayed. It contains up to eight video standard options: Auto-detect, NTSC 3.58, NTSC 4.43, PAL, SECAM and, depending on which version of the decoder is installed, three more PAL options (see right). The current option is indicated by a check mark. Auto-detect is the default. When "Auto-detect" is selected, the decoder automatically determines the video standard of the input signal and processes it accordingly. Alternatively, you can force the decoder to use a particular decoding method by selecting one of the other menu options. This should only be necessary for poor quality input signals.

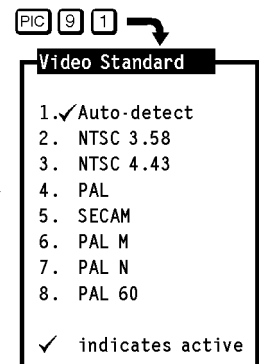

Signal Routing

When item 2 is selected from the Decoder Options menu, the Signal Routing menu is displayed. It contains four signal routing options: Auto-detect, As Composite, As S-Video, and As RGB. The current selection is indicated by a check mark. Auto-detect is the default. When “Auto-detect” is the selected option, the projector determines whether the input signal requires routing through the decoder according to the type of interface used. For example, if the source is an RGB input connected to the RGB interface, the signal will bypass the decoder since video decoding is not required. However, if the input is a composite signal connected to a composite/S-video interface, the projector will route the signal through the decoder for processing.

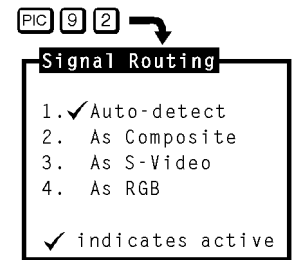

If “As Composite” is the selected option, the projector assumes the input signal is composite video and processes it through the decoder. If “As S-Video” is the selected option, the projector expects the input signal in the form of separate Y and C signals. If “As RGB” is the selected option, the projector assumes the signal at the current input is always RGB and the decoder is bypassed. One reason for not using Auto-detect is to allow connection of a composite or S-Video signal to a standard RGB interface and still have the projector process the input correctly through an installed decoder; otherwise, a composite/S-video interface would be required. Figure 3-6 illustrates the connection of a composite or S-Video signal to an RGB input (the projector’s built-in RGB input is shown as an example).

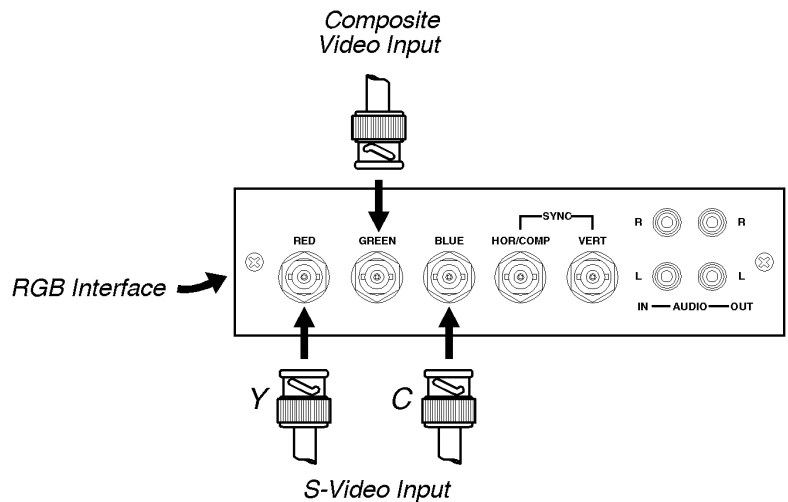

Figure 3-6. Connection of Composite Video or S-Video to RGB Input (Multi-Standard Decoder Option Required)

About the Sync Routing System

The Sync Routing System allows various sync and video combinations to be made to the Input 01 or 02 on the Video Input Module. You can connect Video signals with Separate sync (R-G-B-H/C-V), Composite sync (R-G-B-H/C) or Sync-On-Green (R-Gs-B).

As well, the routing system allows Composite Video signals to be connected through the Green BNC and routed to the Marquee Decoder as long as the Recall (or Input) memory assigned to the Composite Video source is set for routing as Composite Video. From the PIC menu, select “Signal Routing” (item 9), then select “As Composite” (item 2) in order to force the routing to the Marquee Decoder.

Similarly, the system allows you to connect S-Video (Y/C) signals to the Red (for Y) and Blue (for C) BNCs, where they are routed to the Marquee Decoder if the Recall (or Input) memory assigned to the S-Video source is set for routing as S-Video. From the PIC menu, select “Signal Routing” (item 9). Then select “As S-Video” (item 3) in order to force the routing to the Marquee Decoder.

The IC at the U41 location on the Video Input Module (VIM) determines the priority and routing of incoming and outgoing sync. The VIM also includes Sync-On-Green circuitry which strips sync information from signals connected to the Green BNC. The IC then outputs the appropriate sync from the VIM to the Deflection Processor Board (DPB), which locks the operating frequency of the projector to the sync it receives. Set “Auto Clamp” in one of two ways, as described below.

- 1) If the routing is set to either “As Composite” or “As S-Video”, setting “Auto Clamp” to “On” routes the sync to the DPB from the Decoder. This setting is required for S-Video to operate properly. It also allows Composite Video to operate. Setting “Auto Clamp” to “Off” routes the sync to the DPB from the Sync-On-Green circuitry. This is valid for Composite Video operation only, since the Composite Video is connected to the Green BNC. (NOTE: If using a Composite Video source with ASR, “Auto Clamp” must be set to “off. This is required for source change detection which is an integral part of ASR operation. When “Auto Clamp” is set to “Off”, you must set the “Horiz Position” slider to approximately 25. This is due to a phase delay between the sync from the decoder and the sync from the Sync-On-Green circuitry.)
- 2) In all other cases – that is, when NOT routing the signal to the decoder – setting “Auto Clamp” to “On” results in back-porch clamping. If Sync-Tip clamping is required, set “Auto Clamp” to “Off.”

Geometry Functions

Geometry functions are accessed through the Geometry menu. To display this menu, press **GEOM**.



Note: It is usually easier to adjust display geometry while a test pattern () is displayed.

GEOM 1

Size

The Size function is used to adjust the horizontal and vertical size of the display image. (This adjustment is also available through the Picture menu).



To adjust size, select Size from the Geometry menu. Two sliders are displayed: a Horizontal Size slider and a Vertical Size slider. Press **▲** or **▼** to adjust vertical size, and **◀** or **▶** to adjust horizontal size until the objects within your picture have the proper shape. For example, if there is a circle in your picture, size should be adjusted so that the circle is round, not oval.

Note: The Size function should not be used to compensate for aspect ratio mismatches between source images and the projection screen. Not all sources use the same aspect ratio therefore it may not always be possible to fill the entire screen. ("Aspect Ratio" is defined in Appendix A).

GEOM 2

Keystone

The Keystone function adjusts side keystone geometry distortion. Adjust keystone to change the width at the top of the display in relation to the width at the bottom. The displays below demonstrate keystone adjustment.



To adjust keystone, select Keystone from the Geometry menu then press **◀** or **▶** to adjust the top and bottom widths of the display as desired.

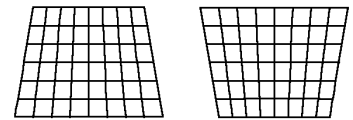

GEOM 3

Side Pin

The Side Pincushion function adjusts pincushion of the sides of the display image.

The two displays shown below demonstrate side pincushion adjustment.



To adjust side pincushion, select Side Pin from the Geometry menu then press **◀** or **▶** until the sides of the image are as curved or as straight as desired.

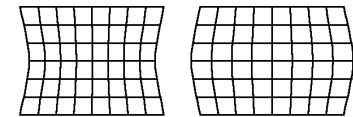

GEOM 4

Top

The Top function adjusts the level (Top Key) and pincushion (Top Pin) of the top half of the display image. The four displays shown here demonstrate Top adjustments.

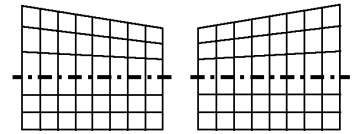

To stretch the upper left or right corner up or down, select Top from the Geometry menu and press **←** or **→**. To adjust top pincushion, press **▲** or **▼** until the top half of the image is as curved or as straight as desired.

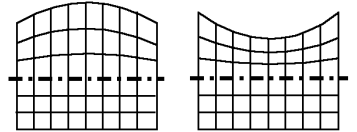

GEOM 5

Bottom

The Bottom function adjusts the level (Bottom Key) and pincushion (Bottom Pin) of the bottom half of the display image. The four displays shown at right demonstrate Bottom adjustments.

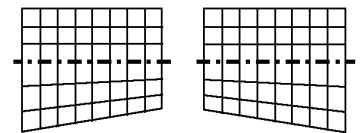

To stretch the lower left or right corner up or down, select Bottom from the Geometry menu and press **←** or **→**. To adjust bottom pincushion, press **▲** or **▼** until the bottom half of the image is as curved or as straight as desired.

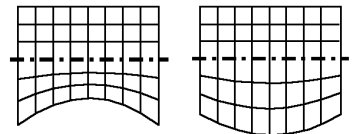

GEOM 6

Bow

The Bow function adjusts horizontal bowing (H Bow) across an image. It also adjusts vertical curvature (V Bow) in the middle of the picture. The four displays at right demonstrate H Bow and V Bow adjustments.

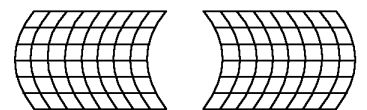

To adjust H bow, select Bow from the Geometry menu then press **←** or **→** until the image appears as desired. To adjust V Bow, press **▲** or **▼** until the center of the picture is as curved or as straight as desired.

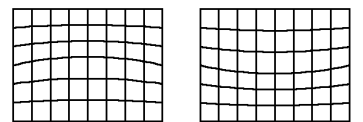

GEOM 7

C Linearity

The C Linearity function corrects for gradual non-linearity between the top and bottom or left and right sides of the display image. Examples are shown below. In the first example the top of the image increases in vertical size while the bottom decreases in vertical size. In the second example the right side of the image increases in horizontal size while the left side decreases in horizontal size.



Select C Linearity from the Geometry menu. It is best to have a screen full of characters displayed. Or use one of the internal test patterns available by pressing **#**. If there is a vertical non-linearity, press **▲** or **▼** until the characters at the top, middle, and bottom of the screen have the same vertical size. If there is a horizontal non-linearity, press **◀** or **▶** until the characters at the left, middle, and right of the screen have the same horizontal size.

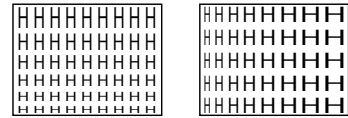

GEOM 8

S Linearity

The S Linearity function corrects for vertical and horizontal non-linearities which extend from the center of the display to the top and bottom or left and right. Examples are shown below. Notice how the top and bottom or left and right characters are much smaller in size than the center characters.



Select S Linearity from the Geometry menu. It is best to have a screen full of characters displayed. Or use one of the internal test patterns available by pressing **#**. If there is a vertical non-linearity, press **▲** or **▼** until the characters at the top, middle, and bottom of the screen have the same vertical size. If there is a horizontal non-linearity, press **◀** or **▶** until the characters at the left, middle, and right of the screen have the same horizontal size.

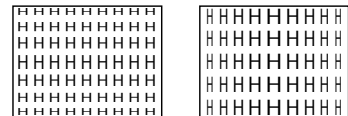

GEOM 9

Skew

The Skew function adjusts the display image so that the sides of an image appear to be leaning to one side and/or shifted up or down. The two displays below demonstrate skew adjustment.



To adjust H Skew, select Skew from the Geometry menu then use **◀** and **▶** until the image is slanted from side to side as desired. For V Skew, press **▲** or **▼** to slant up or down.

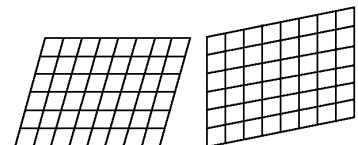

3.6 Convergence Registration

Convergence Registration is the process of aligning the red, green, and blue color components on the projection screen. The projector's convergence system provides accurate color registration in 45 discrete convergence zones configured in a 9 by 5 array on the projection screen. Since the projector must converge colors differently for each source (due to varying scan frequencies), convergence settings are saved for each input. Convergence settings can also be saved in Recall memories.

There are three basic convergence methods available: Guided, Interpolated, and Random Access. Any one of these can be selected for performing a registration adjustment. All are easy to use and context-sensitive help is available if needed. With the ACON feature, the convergence process is completely automated. ACON provides fast, accurate convergence, and is especially helpful when many inputs must be converged, or when the projector installation position frequently changes.



To perform a convergence:

Begin by selecting the input source to be converged. Convergence settings will be saved in the current setup memory. Next, press **CONV** to display the Convergence menu. Select one of the convergence options from the menu. Guided Convergence provides a complete guided convergence of the red and blue images onto the green image in all 45 convergence zones. Use this option if the image requires minor convergence alignment and you wish to be guided through the 45 convergence zones.

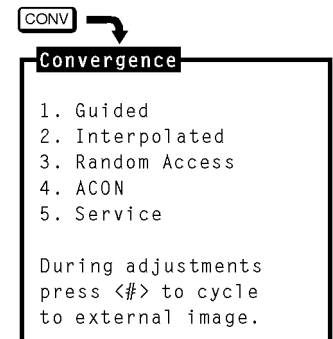

Note: If the projector does not include the ACON automatic convergence feature, item 4 is "ACON (not installed)".

Interpolated Convergence provides a complete convergence similar to Guided but is recommended when the image requires major convergence alignment (and should be used the first time a source is converged).

Random Access Convergence allows you to converge a particular area of the display. Any zone may be quickly selected and converged. This option also allows convergence of the blue on the red image (if preferred to the normal blue on green).



ACON is a feature that provides fast, accurate automatic convergence in all 45 convergence zones. Minimal user intervention is required. If the projector does not include ACON, item 4 in the menu reads "ACON (not installed)."

The Service selection is used to access the convergence service utilities. These utilities are provided for qualified service personnel only. (Password access is required).

The following options are available while performing any of the manual convergence routines:

Convergence on Image

When a convergence method is first selected, an internally generated crosshatch test pattern is displayed. Alternatively, you may override the use of the test pattern and have the external image displayed. Press **[#]** to cycle to the external image.

Convergence Reset

During convergence, the following reset options are available:

- Press **[0]** to reset red and blue convergence – static and dynamic.
- Press **[1]** to reset red and blue convergence – static only.
- Press **[2]** to reset red and blue convergence – dynamic only.

“Static” refers to the complete image. “Dynamic” refers to a zonal area.

Note: Allow the projector to warm up for at least forty five minutes prior to convergence registration.

Guided ➤
Convergence

Press **[3]** from the Convergence menu to select Guided Convergence. An internally generated crosshatch is displayed for the alignment. Initially, a red and green crosshatch is displayed and a rectangular box surrounds the center convergence zone. Use **[←]**, **[↓]**, **[→]**, and **[↑]** to move the red onto the green in the zone. Press **[ENTER]** to similarly move the blue onto the green. These first two adjustments adjust the position of the red and blue images with respect to the green over the entire screen (static adjustments). The adjustments to follow (dynamic), modify color positioning within individual zones.

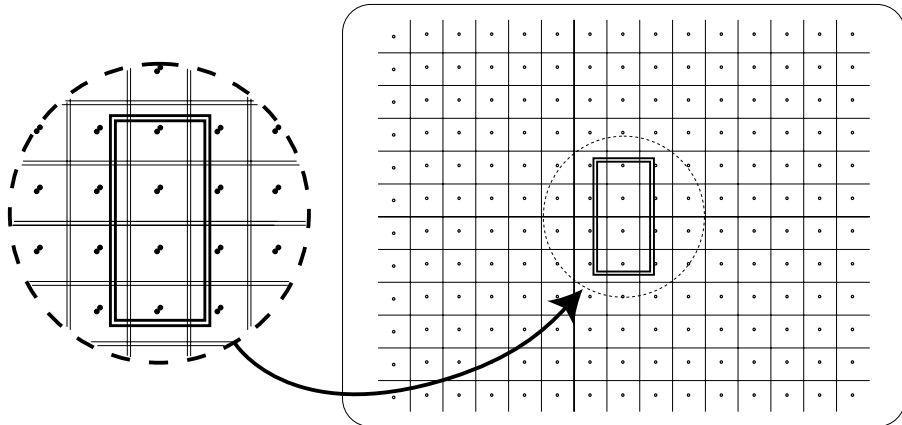

Press **[ENTER]** to move the rectangular box to the next convergence zone. Again, use the arrow keys to adjust the red on the green. Press **[ENTER]** to adjust the blue on the green.

Within each zone, a central control point defines the position of each color within the zone. You will notice that the center position within the box is most sensitive to the adjustment. This is where the control point is located. Continue using **ENTER** to move to the next zone/color for adjustment. If you wish to go back to a previous zone, press **↩**. Once all 45 zones have been converged an Exit dialog box is displayed, as shown below. If you wish to exit prior to converging all 45 zones, **EXIT** will immediately display the Exit dialog box.

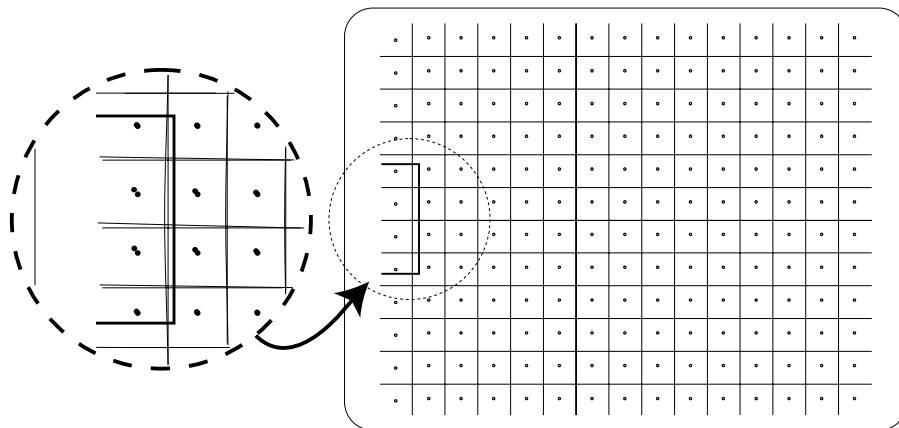

*Note: **CONV** may be used instead of **ENTER** to change zones/colors, if preferred.*

When the Exit dialog box is first displayed, the cursor bar is positioned on “Save.” Press **ENTER**, **EXIT** or **RECALL** to save the new settings. To re-perform the convergence, move the cursor bar to “Continue Adjust” then press **ENTER**. To discard your changes, move the cursor bar to “No Save” then press **ENTER**, **EXIT** or **RECALL**.

Exit Convergence		
Save	No Save	Continue Adjust

Interpolated Convergence ➤

Press **↩** from the Convergence Menu to select Interpolated Convergence. Interpolated Convergence is performed in the same way as that described for Guided convergence. The primary difference between Guided Convergence and Interpolated Convergence is noticed during adjustment. In Interpolated convergence, adjustments are not limited to single zones, but will affect larger regions of the raster. Response is greatest within the displayed box and decreases linearity towards zones which have already been converged in the sequence. Interpolated convergence is recommended when converging a source for the first time. This method can be much faster than guided convergence. However, it is not recommended if only minor convergence alignment is required.

**Random Access
Convergence** ➤

Press **CONV** from the Convergence menu to select Random Access Convergence. A red and green crosshatch is displayed with a rectangular box at the center zone. Above the box, "CONV" indicates that the zone is ready for convergence. Use the arrow keys to move the red onto the green within the box. This affects the position of the red with respect to the green over the entire screen (static convergence).

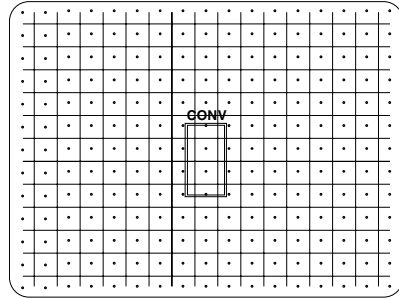

To change the convergence color, press **COLOR**. Each press of the Color key changes the color as shown.

SEQUENCE Press:	REFERENCE COLOR	CONVERGENCE COLOR
1. COLOR	green	blue
2. COLOR again	red	blue
3. COLOR again	a white crosshatch for reference	
4. COLOR again	repeat starting at green-red	

To move to another control point, press **ENTER**. The caption above the box changes to "MOVE." Use the arrow keys to move to another zone for convergence. Press **ENTER** to converge the zone. When all zones requiring adjustment are converged, press **EXIT** to display the Exit dialog box. Press **ENTER** to save the new convergence settings. To go back to the convergence screen, move the cursor bar to "Continue Adjust", then press **ENTER**. To discard your changes, select "No Save."

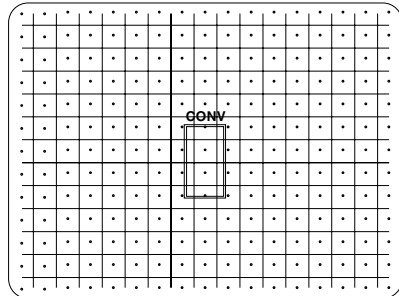

*Note: **CONV** may be used instead of **ENTER** to alternate between converge and move functions, if preferred.*

ACON Automatic Convergence ►



Press **[4]** from the Convergence Menu to display the ACON Auto-Convergence Menu. The menu displays five ACON options for selection and shows the most recent ACON status message (if there is one).

Note: The ACON Auto-Convergence Menu is available only if the ACON module is installed.

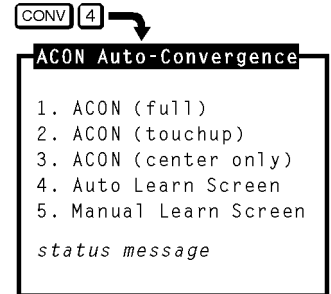

Before using ACON for the first time it is important to understand how ACON operates. ACON consists of two primary components; a Locator Assembly, normally mounted to the front of the projector, and an ACON Control Board, located inside the projector. The Locator Assembly includes a photosensor which, via two stepper motors, can monitor any point on the display screen. The ACON Control Board controls the viewing position of the photosensor. During automatic convergence, small red, green, and blue targets are displayed for viewing by the photosensor. Data from the photosensor is analyzed and convergence adjustments are made accordingly. The lens of the Locator Assembly can be observed to move about as each convergence zone is analyzed and adjusted. No user intervention is required.



WARNING: IN RARE INSTANCES, FLASHING LIGHTS CAN TRIGGER AN EPILEPTIC SEIZURE. DURING ACON OPERATION PERSONS WITH EPILEPSY SHOULD NOT WATCH THE SCREEN.

Automatic Convergence – Full, Touchup, and Center Only

Options 1, 2 and 3 in the ACON Auto-Convergence Menu provide selection of three automatic convergence routines; ACON (full), ACON (touchup), and ACON (center only). If the image has never been converged or is poorly converged, select option 1, ACON (full). If the image has been previously converged and only minor touch-up is required, select option 2, ACON (touchup). If the red or blue image has shifted position and is not registered with the green, select option 3, ACON (center only).

Note: It is important to have a good lighting environment when using ACON. Dimmed incandescent lighting is preferred over fluorescent lighting. Avoid shadows on the screen.

When ACON (full) is selected, ACON converges the red and blue to the green at all 45 convergence zones. As each zone is converged, surrounding zones are also adjusted by ACON’s proprietary interpolation software. This software provides fast, accurate convergence adjustment of poorly converged images.

During automatic convergence you will notice a small red, green, or blue square briefly displayed at each zone location. It is at that time that ACON is analyzing and adjusting the convergence. Full automatic convergence takes approximately three minutes to complete.

ACON (touchup) also converges at all 45 convergence zones. It is different than ACON (full) in that as each zone is converged, surrounding zones are not affected. It is faster than full auto-convergence and provides optimal convergence alignment when only minor adjustment is required.

When ACON (center only) is selected, the full red and blue image positions are adjusted based on the misconvergence at the center of the display.

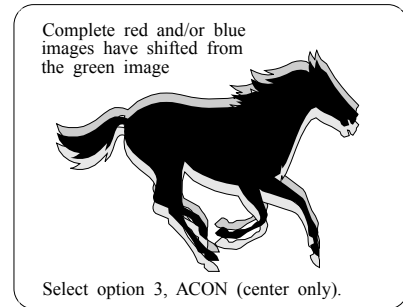
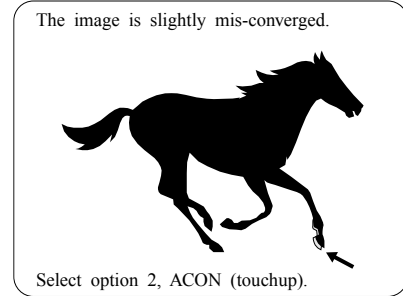
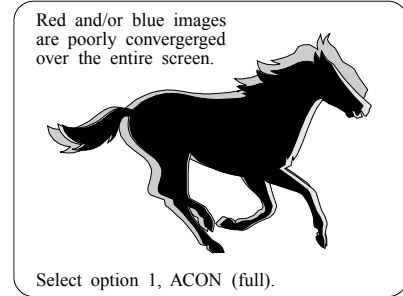

When convergence is complete, an Exit dialog box is displayed with the cursor bar positioned on “Save.” To save the new convergence settings, press **ENTER**, **EXIT** or **RECALL**. To discard the changes, move the cursor bar to “No Save” then press **ENTER**, **EXIT** or **RECALL**.



Error Messages

If ACON encounters a problem which it cannot resolve, processing halts and an error message is displayed. If you encounter an error message, refer to section 4.3, Troubleshooting for assistance. If you are unsure how to resolve the problem, contact your dealer. To return to the previous convergence settings, press **ENTER** or **EXIT** with the cursor bar positioned on “No Save”; otherwise, move the cursor bar to “Save” then press **ENTER** or **EXIT**.



Interrupting ACON

If you want to interrupt ACON during an automatic convergence, press **EXIT**. Shortly thereafter an Exit dialog box will be displayed with the cursor bar positioned on “No Save.” To quit ACON and discard the convergence adjustments made up until that point, press **ENTER** or **EXIT**. To quit ACON yet retain the new convergence settings, move the cursor bar to “Save” then press **ENTER** or **EXIT** (to examine the convergence quality, press **#** to display a crosshatch). To return to ACON, move the cursor bar to “Continue ACON” then press **ENTER** or **EXIT**.

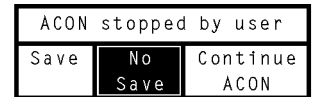

Learn Screen – Auto, Manual

Options 4 and 5 in the ACON Auto-Convergence menu allow you to perform an ACON Learn Screen. A Learn Screen must be performed prior to automatic convergence so that ACON knows the exact screen position, relative to the Locator Assembly. Learn Screen is usually required only once for each new installation. A Learn Screen **MUST** be performed when one of the following conditions exist:

- The throw distance has changed since the last Learn Screen.
- The ACON Locator Assembly mounting position has changed since the last time Learn Screen was performed.
- The screen type or size has changed.
- The source has changed.

Before performing a Learn Screen, make sure the projector is fully set up and adjusted for the installation. It is important that all focus and geometry adjustments have been made.

Two Learn Screen options are available: Manual Learn Screen and Auto Learn Screen. Manual Learn Screen (menu option 5) is the preferred method for performing a Learn Screen; it requires some user assistance but assures the best possible Learn Screen. Auto Learn Screen, which requires no user assistance, works well in installations where ACON can easily determine the screen limits. The screen limits may be difficult for ACON to determine if the installation is a rear screen, the ambient light conditions are poor, or the top the screen meets the ceiling. If an Auto Learn Screen was used but ACON had difficulty determining the screen limits, the quality of subsequent convergences will be affected – especially near the screen edges and corners. Until you have experience using ACON for the installation, it is recommended that Manual Learn Screen be used; the time required to perform a Manual Learn Screen is typically less than sixty seconds.

When Manual Learn Screen is selected, a screen similar to that shown below (left diagram) is displayed. Use **▲**, **▼**, **◀** and **▶** to move the four black bars to the outside edges of the screen. Initially, the arrow keys control the top and left bars, as indicated by the bottom line of the text box. To move the right and bottom bars, press **ENTER** then use the arrow keys.

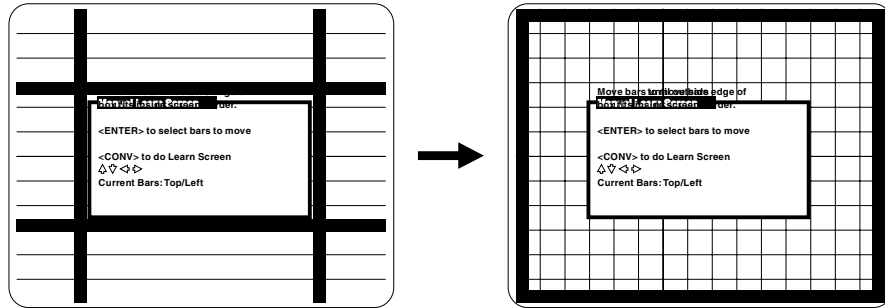

For each bar position being adjusted, watch the bar width as it moves closer to the screen edge. If the bar starts to overlap the screen border and reduce in width, move it back one increment so that it is displayed in its entirety. If the bar is as far as it will go and it is displayed in its entirety, leave it at that position. If you notice a geometry distortion during Learn Screen, such as keystone or pincushion, use **GEOM** to correct it.

When all bars have been adjusted, press **CONV** to continue with the Learn Screen operation. The remainder of the Learn Screen process is handled automatically by ACON. Wait until it is complete, at which time the ACON Auto-Convergence Menu is returned.

If an error occurs during either of the Learn Screen functions, processing halts and an error message is displayed. Refer to section 4.3, *Troubleshooting*, for assistance. Also, if during a Learn Screen you want to interrupt ACON, press **EXIT**. Shortly thereafter an Exit dialog box will be displayed. Follow the screen instructions to exit or continue.

3.7 Utility Features

The projector's utility features allow you to customize operation of the projector to suit your application and preferences. To access these features, press **UTIL**. The Utilities menu is displayed.

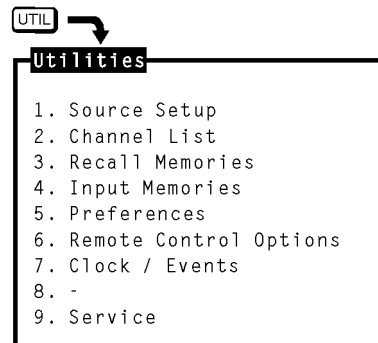

Item 1, Source Setup, provides utilities for setup memory manipulation and selection of internal sources.

Item 2, Channel List, allows you to program the Channel List.

Item 3, Recall Memories, displays a listing of the Recall memories stored in the projector.

Item 4, Input Memories, displays a listing of the Input memories stored in the projector.

Item 5, Preferences, lets you set various operational settings which affect the behavior of the projector, according to your preferences.

Item 6, Remote Control Options, allows you to modify the projector's communication settings for communication with external control devices such as remote keypads.

Item 7, Clock/Events, allows you to set the projector's real-time clock/calender and program up to twelve individual projector control events to be automatically executed at specified times or intervals.

Item 9, Service, provides service utilities for use by authorized service personnel. (Password access is required.)

Source Setup ➤

Source Setup utilities are accessed by pressing **UTIL** from the Utilities menu. Six source related utilities are available.

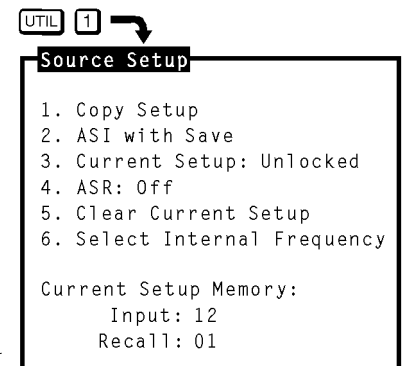

UTIL **1** **1**

Copy Setup

The Copy Setup utility is used to copy stored display settings from one setup memory to another. When a copy is made, the originating memory remains unchanged and the destination memory is overwritten with the settings of the originating memory.



To copy a setup memory, press **UTIL** from the Source Setup menu. A dialog box is displayed. Enter the setup memory you want to copy from and the setup memory you want to copy to. Input memories are entered by pressing **SOURCE** followed by a switcher and slot number. Recall memories are entered by pressing **RECALL** followed by a two digit Recall memory number (01 to 99).

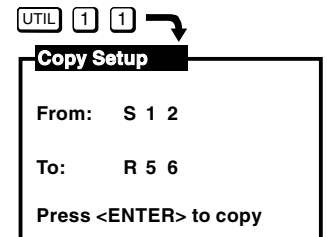

Once complete, press **ENTER** to proceed with the copy. A “Copy Complete” message is briefly displayed to indicate a successful copy. When you are finished copying setup memories, press **EXIT** to return to operation level.

UTIL **1** **2**

ASI with Save

ASI (Automatic Source Interpolation) is a feature which automatically adjusts display settings based on the settings of other setup memories stored in the projector. The “ASI with Save” utility performs an immediate ASI on the current source and saves the resulting display settings in the current setup memory. The new settings are created by either copying the settings from another setup memory which has matching scan frequencies or by

interpolating between “the two closest” setup memories. This feature is very useful when adding a new source to the system and/or when much adjustment is required. By using the “ASI with Save” feature, the projector can do most of the required adjustments for you.



To perform an “ASI with Save”, press **2** from the Source Setup menu. A dialog box is displayed. Press **4** to move the cursor bar to “Do It” then press **ENTER**. New display settings will immediately be calculated and saved in the current setup memory. The only exception is when the current setup memory is locked. If locked, display settings will not be modified. If “Cancel” is selected from the dialog box, the operation is stopped. For more information about the ASI logic process, refer to Appendix C, *ASR/ASI Logic Diagrams*.



Notes about the ASI feature ...

ASI works better when there are many setup memories in the system. For example, if you always use the same input and you never use Recall memories (thus only one setup memory has ever been created), ASI will not be effective. However, if many Input and Recall memories have been used and adjusted for a variety of sources, the projector has more “knowledge” in its database for performing an ASI. As this “knowledge” increases, ASI accuracy improves.

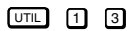

Current Setup (Locked/Unlocked)

This utility allows you to lock or unlock the current setup memory. Locking a setup memory prevents changes to display settings from being saved in that memory. For example, if a locked Recall memory is selected and then brightness is adjusted, the new brightness setting is only temporary. If the Recall memory is reselected, the original brightness setting will be restored.

Note: When a locked setup memory is selected, a key icon () is displayed in the Source Message.



To lock or unlock the current setup memory, press **3** from the Source Setup menu. Item 3 in the menu indicates the current setting.



ASR (On/Off)

The ASR (Automatic Source Recall) feature provides automatic Recall memory selection or ASI (Automatic Source Interpolation) for inputs which have ASR set to On.



To turn ASR on or off for the current input, press **4** from the Source Setup menu. Item 4 in the menu indicates the current setting.

When ASR is on, the projector monitors the current input for horizontal and vertical scan frequency changes. When a frequency change occurs, the current Input memory and all Recall memories are scanned in search of a memory with matching scan frequencies. If one exists, this memory becomes the current setup memory. If a matching memory is not found, an ASI is performed. ASI automatically adjusts display settings based on the settings of other setup memories stored in the projector. The new settings created by ASI are either a copy of the settings from another setup memory which has matching scan frequencies or an interpolation between “the two closest” setup memories.

ASR is also performed when:

- You switch to an input which has ASR set to On.
- You select a Recall memory and ASR is set to On for the current input.
- A channel is selected which specifies an input which has ASR set to On.
- The source frequencies are different than the frequencies in the setup being selected.

When ASR selects a setup memory, a source message is briefly displayed to indicate which memory was selected. If the new memory settings (Input and Recall) match that of one of the channels in the Channel List, the matching channel is used and displayed in the source message. Display adjustments, if made, are stored in the new memory (unless it is locked).

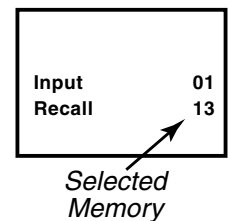

If, on the other hand, an ASI is performed, a source message is briefly displayed which includes an ASI message to indicate the action taken. If an Input memory with matching scan frequencies was found by ASI, its settings are used and its identity is displayed. If an interpolation was performed, the two setup memories selected for the interpolation are displayed and the resulting settings are used. If adjustments are made to settings created by the ASI feature, the new settings will NOT be saved in the current setup memory; a message is displayed to indicate this. To perform an ASI and have the adjustments saved in the current setup memory, press **UTIL** **1** **2** to select the ASI with Save utility.

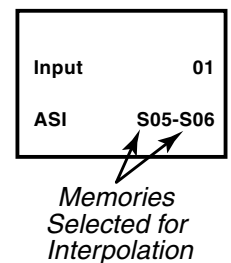

*Note: To avoid selection/use of the current Input memory settings when it is desired that Recall memories be ASR selected when a source change occurs, clear the current Input memory (**UTIL** **1** **5**) to reset its scan frequency settings to null values, then immediately lock the memory (**UTIL** **1** **3**) so that its settings cannot be modified.*

For more information about the ASR logic process, refer to Appendix C, *ASR/ASI Logic Diagrams*.

When to use the ASR feature...

The ASR feature is intended for use when many different sources must share the same input (via a third party switcher, for example) or when a signal source can output several different scan frequencies (e.g., a SVGA card).

Example

A system has six different sources as shown in Figure 3-7. Source "A" is a video camera. Source "B" is a VCR. Sources "C" through "F" are various computers. All sources are connected to a 3rd party (non-Madrigal Imaging) signal switcher. The switcher is connected to projector slot 1. For each source, a Recall memory is created to store its display settings. No two sources have the same frequencies.

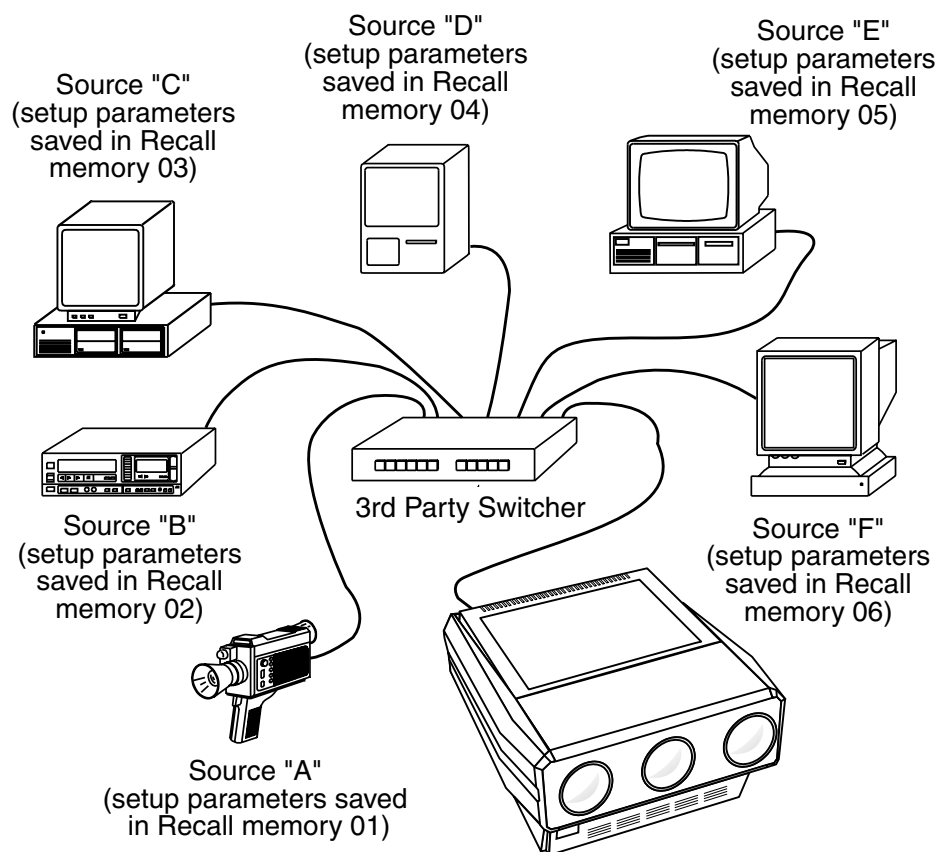

Figure 3-7. *An Installation using the ASR Feature*

UTIL **1** **4** is pressed to turn on the ASR feature for the projector's slot 1 input. When ASR is on and a source is selected by the switcher, the projector automatically adjusts its display settings for the new source by switching to the Recall memory set up for that source.

For additional information, see "About the Sync Routing System" in Section 3.5, subsection Decoder Options.

UTIL 1 5

Clear Current Setup

This utility is used to clear the current setup memory to the factory default display settings.



To clear the current setup memory, press **[5]** from the Source Setup menu. A dialog box is displayed. Move the cursor to “Do It” then press **[ENTER]** to clear the memory. If you press **[ENTER]** with the edit cursor on “Cancel”, the clear operation is not performed. When the clear operation is complete, the Source Setup menu is returned.

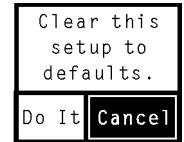

Note: Clearing a setup memory does not “delete” it from the system. If the projector’s 75 memory spaces are used up, and you need to delete unused memories to make room for new memories, call your dealer for assistance.

UTIL 1 6

Select Internal Frequency

This utility allows you to use the projector’s internal signal generator. The internal signal generator is provided to assist users and technicians during projector setup. By using the internal generator, a setup memory can be adjusted for a particular set of horizontal and vertical scan frequencies without requiring an external source. Six preset horizontal and vertical frequencies are provided.

If one of the preset frequency sets closely match a source you will be using, you can set up an Input or Recall memory for the source before it is available for connection to the projector. When the source becomes available, few adjustments will be required. Another reason to use the internal generator is to improve the accuracy of the ASI feature. By setting up various memories at different scan frequencies, ASI has more information to choose from when making interpolations between setups.



To select an internal frequency, press **[6]**, “Select Internal Frequency” from the Source Setup menu. The resulting menu allows you to choose the scan frequencies of the internal generator. Select one of the displayed items.

UTIL 1 6

	Horiz	Vert
1.	15.73	59.94
2.	31.47	59.94
3.	47.71	71.90
4.	62.50	66.67
5.	89.30	70.00
6.	126.84	60.00

To make a selection, enter an item number or use **[←]** and **[→]** to move the cursor bar to the item you want then press **[ENTER]**. When a selection is made, a crosshatch test pattern is displayed. All subsequent adjustments are saved in the current setup memory. To select one of the projector’s other test patterns, press **[#]**. Each press of **[#]** produces a different test pattern. To return to the current external source, press **[EXIT]** while only the test pattern is displayed.

Channel List ➤ The Channel List utility allows you to display and program the projector's Channel List. The Channel List is a user-programmable list of sources and projector setups. Sources added to the list can be quickly switched to and displayed by entering their assigned two-digit channel number. Channels may also be selected using the keypad's up and down arrow keys. Channel selection is described in section 3.3, *Source Selection*.

To display and/or program the Channel List, press **UTIL** from the Utilities menu. The initial display shows the first ten channels in the list. Up to 99 channels can be displayed. For each channel a name, input number (switcher and slot number), Recall memory number, and up/down list may be programmed.



Program a channel as follows:

When the Channel List is first displayed, the cursor is positioned in the channel number column. While in the channel number column, press **▲** or **▼** to highlight the channel you want. Alternatively, you can highlight the channel you want by entering the channel number on the keypad. Entering the channel number also allows you to select/display/edit channels beyond the first ten.

UTIL **2** →

Channel List				
CH	NAME	INPUT	RECALL	U/D
01	COMPUTER A	02	04	
02	COMPUTER B	14	01	
03	VCR	12		✓
04	VGA	23		✓
05	VGA MODE 2	23		
06				
07				
08				
09				
10				

<2 digit no.> or **▲** **▼** to select channel
▶ to edit selected channel

Next, press **ENTER** to move the cursor to the Name field. While in the Name column, **▲** and **▼** change the character at the cursor position **▲** and **▶** move the position of the cursor. Once a source name has been entered, move the cursor to the Input field by pressing **ENTER** or by using **▶**. Edit the Input, Recall, and Up/Down (U/D) fields. See below for field definitions. To exit the channel list, press **RECALL** or **EXIT**.

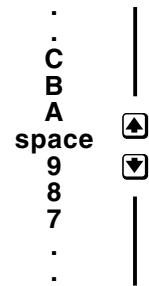

*Note: When the cursor is positioned on a edit field, the field may be cleared by pressing **RECALL**.*

NOTE: If a channel is selected and ASR is on for the same input, and the incoming frequency does not match the selected setup memories frequency, it may cause the following: ASR may be triggered, the setup memory may change and the channel number may be changed to reflect the new memory.

Example: If Channel 4 shows input (1,3) and no recall number and input (1,3) switcher 1 slot 3 is selected and recall memory 55 is currently selected then the Source Message box will show that Channel 4 is selected unless there is another channel with input (1,3) and recall 55.

The Name Field

The Name field stores the names of the sources in the list. Source names may be up to 11 characters in length. It is recommended that source names be entered to make it easier to keep track of the sources. Source names are briefly displayed when channels are selected.

Notes: 1) Digits may be entered using the number keys on the keypad or selected using the \blacktriangleleft and \blacktriangleright keys. 2) If ⌫ is pressed during name editing, all characters in the field to the right of the cursor will be cleared.

The Input Field

The Input field contains the switcher and slot number of the input to be switched to when the channel is selected. If the input is a direct projector input, the input number is a 0 followed by the projector slot number. If the input is from a switcher, the input number is a number from 1 to 9 (switcher number) followed by the switcher slot number.

The Recall Memory Field

The Recall Memory field contains the number of the Recall memory to be used when the channel is selected. If the field does not contain a number (a blank or dash is shown), no Recall memory will be used.

The Up/Down Field (U/D)

The Up/Down field specifies the channels which are accessible when using up/down channel selection (explained in section 3.3). If the field does not contain a check mark, the channel is ignored. To enter a check mark, press a number key (0-9). To clear a check mark, press ⌫ .

Note: Channels should contain valid inputs. For example, do not specify switcher 1 if switcher 1 does not exist in the system.

Recall Memories ► (Listing)

The Recall Memories utility provides a list of the Recall memories stored in the projector. (Recall memories are explained in section 3.4). The list includes the scan frequencies of each Recall memory. A check mark (✓) is displayed in the ASR column next to the memories which ASR may use. If two or more Recall memories have identical scan frequencies, only the memory last adjusted will have a check mark.

UTIL 3

Recall Memories							
Re	Horiz	Vert	ASR	Re	Horiz	Vert	ASR
01	31.50	60.00	✓	16	55.50	66.00	✓
02	50.80	66.00	✓	17	33.50	63.00	✓
03	54.00	71.90	✓	18	43.20	50.00	✓
04	45.56	75.00	✓	19	24.00	60.00	✓
05	50.00	60.00	✓				
06	62.50	70.00	✓				
07	55.00	60.00	✓				
08	54.00	66.00	✓				
09	61.10	71.90	✓				
10	31.50	60.00					
11	33.00	60.00	✓				
12	44.00	70.00	✓				
13	56.50	66.00	✓				
14	54.00	71.90	✓				
15	28.75	75.00	✓				

✓ - can be used by ASR

To list the Recall Memories, press **3** from the Utilities menu. If more than 30 Recall memories exist, press **ENTER** to display the remaining memories.

Input Memories ➤
(Listing)

The Input Memories utility provides a list of the Input memories stored in the projector. (Input memories are explained in section 3.4). The list includes the scan frequencies of each Input memory. The ASR column indicates if the ASR feature is on or off for each memory. A check mark (✓) is displayed in the ASR column next to the memories which may be chosen for use by ASI during an ASR. If two or more Input memories have identical scan frequencies, only the memory last adjusted will have a check mark. (ASR is explained in section 3.7, *Utility Features*.)



To list the projector's Input Memories, press **4** from the Utilities menu. If more than 30 Input memories exist, press **ENTER** to display the remaining memories.

UTIL 4

Input Memories							
In	ASR	Horiz	Vert	In	ASR	Horiz	Vert
02	On	35.50	60.00				
11	Off ✓	56.00	75.00				
13	On ✓	60.00	66.00				
12	On ✓	35.50	60.00				
14	On ✓	38.50	80.00				

✓ - can be used by ASR/ASI

Preferences ➤ The Preferences utility allows you to set various preferences which affect the behavior of the projector.



To display the Preferences menu, press **UTIL** from the Utilities menu. Six preference items are displayed with their current settings. Select an item to change its setting. (Defaults shown.)

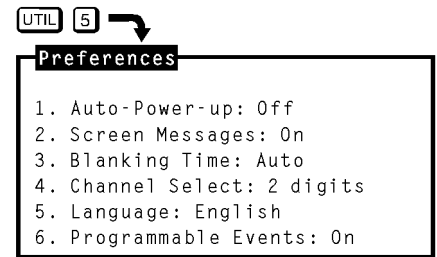

UTIL **5** **1**

Auto Power-up (On/Off)

If Auto Power-up is set to On, the projector automatically powers itself up when line power is removed then re-applied. For example, if power is temporarily interrupted due to a storm, the projector will automatically power back up when power returns. If Auto Power-up were set to Off, the projector would require a manual power-on.

Note: Upon automatic power-up, the most recent display adjustments may be lost if they were not yet saved in the current setup memory.

UTIL **5** **2**

Screen Messages (On/Off)

The Screen Messages preference allows you to choose whether screen messages will be displayed, such as slidebars, error and warning messages, the **SOURCE**, **RECALL**, **PROJ** and **MUTE** messages, and the **PIC** and **GEOM** menus. For most applications, it is recommended that Screen Messages be left on. However, if during a operation you want to make subtle display adjustments without drawing attention to your actions, Screen Messages should be set to Off.

*Note: It is still possible to display a screen message, such as a sidebar, while Screen Messages is set to Off. To do this, press **RECALL** just before selecting the function.*

UTIL **5** **3**

Blanking Time (Auto, 0.5s to 5.0s)

When a source is selected, the projector blanks the screen for a short period of time. You can set the blanking time to Auto, which allows the projector to determine the best blanking time automatically, or program a particular blanking time. Time periods from 0.5 second to 5.0 seconds are available. Select the Blanking Time item in the menu to change its setting.

UTIL **5** **4**

Channel Select (1 Digit Only, 2 Digits, 1 or 2 Digits)

There are three different ways the projector can respond to channel numbers entered during direct channel selection: 1 Digit Only, 2 Digits, and 1 or 2 Digits. Select the Channel Select item in the menu to change its setting.

“1 Digit Only” allows only one digit to be entered after which the projector switches immediately to the selected channel. This method can select only channels 1 to 9. “2 Digits” requires two digits to be entered. Both digits must be entered within 5 seconds. Channel 1 is entered as 01, etc. “1 or 2 Digits” allows either one or two digits to be entered. If a second digit is not entered within 5 seconds of the first, the first digit is accepted as the channel number.

UTIL 5 5

Language (English, French, German, Spanish, Italian)

Menus and text can be displayed in English, French, German, Spanish or Italian. To change the language, select the Language item in the menu until the desired language is shown.

UTIL 5 6

Programmable Events (On/Off)

This item allows you to enable or disable the Programmable Events feature. If Programmable Events is set to On, the events flagged as “ENABLED” in the Programmable Events feature box (UTIL 7 2) are automatically executed at the dates and times specified. If Programmable Events is set to Off, programmable event execution is disabled.

(For information about event programming, refer to the Clock/Events entry in this subsection.)

Remote Control Options

Remote Control Options allow you to modify the projector’s communication settings for operation with remote keypads and control devices.



To select the Remote Control Options menu, press 6 from the Utilities menu. Two selection items are displayed: Keypad Options and Communication Setup.

UTIL 6

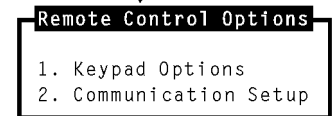

UTIL 6 1

Keypad Options

Press 1 from the Remote Control Options menu to display the Keypad Options menu. Use the menu to select the keypad protocol type the projector will respond.

UTIL 6 1

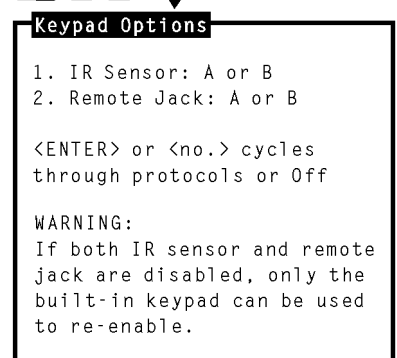

IR Sensor

This setting determines how the projector responds to IR remote keypads aimed at the projector’s built-in IR sensor. Select the IR Sensor menu item to change the current setting. Four settings are available: A or B, A, B, and Off. If set to A, the projector will only respond if the keypad is set for protocol A operation. If set to B, the projector will only respond if the keypad is set for protocol B operation. If set to “A or B”, the projector will respond to both protocol settings. If set to Off, the projector will not respond to IR keypad commands.

The reason for having two protocols available is to allow two projectors in the same room to be independently controlled by separate remote keypads. See Figure 3-8 on the next page.

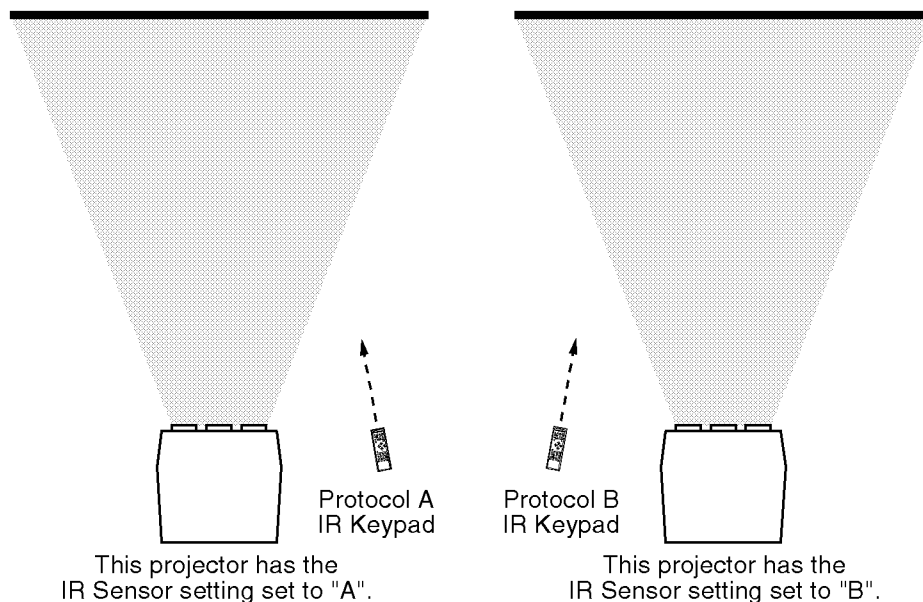

Figure 3-8. Independent IR Keypad Control

Caution: The keypad you are using may become inoperative if its protocol does not match its setting in the menu.

Remote Jack

This setting determines how the projector responds to devices connected to the REMOTE jack on the projector's rear panel. This jack can accept input from a wired keypad or remote IR sensor. Four settings are available: A or B, A, B, and Off. If set to A, the projector will only respond if the keypad using the REMOTE jack is set for protocol A operation. If set to B, the projector will only respond if the keypad using the REMOTE jack is set for protocol B operation. If set to "A or B", the projector will respond to both protocol settings for keypads using the REMOTE jack. If set to Off, the REMOTE jack is disabled.

UTIL 6 2

Communication Setup

Press **2** from the Remote Control Options menu to set the projector identification number and the RS-232 serial port baud rate.

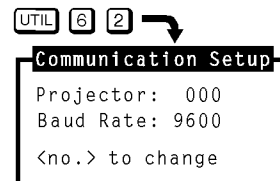

Projector

This item contains the projector's identification number. The projector's identification number allows IR remote control of a single projector in a multi-projector installation. To set the projector identification number, select item 1 then enter a three digit number from 000 to 999. If there is only one projector in the installation, 000 is the recommended projector number. For more information about multi-projector control, refer to section 3.8, *Multi-projector Functions*.

Baud Rate

This item contains the projector's RS-232 serial port baud rate. The RS-232 serial port, located at the back of the projector, provides a means to control the projector using a computer or another projector. The serial port baud rate setting must match the operating baud rate of the controlling device. Baud rate may be set to 300, 600, 1200, 2400, 4800, or 9600. To set the baud rate, select item 2 from the menu until the desired baud rate is displayed.

Notes: 1) If unsure of your computer's baud rate setting, refer to the system documentation provided with the computer. 2) For information about cable connections between devices, refer to Appendix D.

Clock/Events ➤

Clock/Events allows you to set the projector's real-time clock/calender and program up to twelve individual projector control events to be automatically executed at specified times or intervals.



To select the Clock/Events menu press **7** from the Utilities menu. Two selection items are available: Set Clock and Programmable Events. The current time and date setting is displayed at the bottom of the menu.

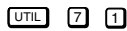
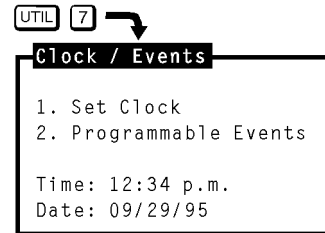

Set Clock

Press **1** from the Clock/Events menu to display the Set Clock Menu. Use menu to set the current time and date and their format.

Time

To edit the time stored in the real time clock/calender, press **1** from the Set Clock menu. This puts you in time editing mode. A flashing cursor is positioned at the first digit of the time field. Use the number keys to enter the current time (hours and minutes), using the format displayed in item 3. For 12 hour format, enter "01" to "12" for the hours and use **▲** or **▼** to toggle between a.m. and p.m. For 24 hour format, enter "00" to "23" for the hours. Enter "00" to "59" for the minutes. When the proper time has been entered and is displayed, press **ENTER** to accept the changes and leave time editing mode.

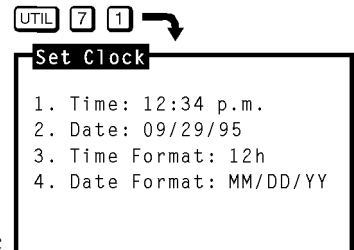

Notes: 1) On entry of the last digit of minutes, you automatically leave time editing mode. 2) Years from 1990 to 2089 are assumed and handled.

Date

To edit the date stored in the real time clock/calender, press **2** from the Set Clock menu. This puts you in date editing mode. A flashing cursor is positioned at the first digit of the date field. Use the number keys to enter

the current date per the format displayed in item 4 (month/day/year, day/month/year or year/month/day). When the proper date has been entered and is displayed, press **ENTER** to accept the changes and leave date editing mode.

Note: On entry of the last digit, you automatically leave date editing mode.

Time Format

Press **3** from the Set Clock menu to change the time display format. The format may be 12 hours (12h) or 24 hours (24h). All references to time by the projector will use the format displayed (this includes the time displayed in item 1.)

Date Format

Press **4** from the Set Clock menu to change the date display format. The format may be month/day/year (MM/DD/YY), day/month/year (DD/MM/YY) or year/month/day (YY/MM/DD). All references to date by the projector will use the format displayed (this includes the date displayed in item 2).

UTIL **7** **2**

Programmable Events

Press **2** from the Clock/Events menu to display the Programmable Events feature box. The Programmable Events feature box allows you to program a list of up to twelve events to occur at specified times and intervals. For example, you can program the projector so that at the same time each day, standby mode is turned off and Source 01 is displayed. See the example below.

UTIL **7** **2** →

Programmable Events			
TYPE	INTERVAL	START	ENABLED
Standby Off	Mon-Fri	07:30a.m.	✓
S 01	Mon-Fri	07:31a.m.	✓
Channel 69	Daily	06:45a.m.	
S 12	Daily	07:15p.m.	
ACON (Center-Only)	12/20/96	11:23p.m.	
Channel Up	Int. 00m 10s	02:00a.m.	
ACON (Full)	Mon-Fri	09:00a.m.	
Power Off	Mon-Fri	04:15p.m.	
None			✓
None			
None			
None			

<ENTER> to change event type

(example shown)

Each line contains a type of event, a frequency of occurrence (interval), a start time and an enable/disable flag.



To program or modify an event, first use the arrow keys to move the cursor to the field you want to modify (for example, the Type field). Next use **ENTER** and/or the number keys to modify that field. Details for field modification are provided on the following pages. Modify each field in the row as necessary making sure all fields for the event are valid and logical.

When all modifications have been made, press **EXIT** to display the Exit dialog box. When the Exit box is first displayed the cursor bar is positioned on “Save.” Press **ENTER** or **EXIT** to save the new changes. To return to the Programmable Events feature box, move the cursor bar to “Continue Change” then press **ENTER**. To discard your changes, move the cursor bar to “No Save” then press **ENTER** or **EXIT**. **ENTER** returns you to the Clock/Events menu. **EXIT** returns you to operation level.

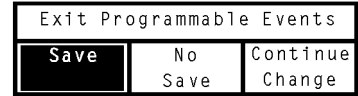

The Type Field

The Type field shows the event to take place. With the cursor positioned on the Type field press **ENTER** to cycle through the available events. Press ***** to clear the entire event line. Events are described in Table 3-1 below.

Table 3-1. Type Field Events

EVENT	DESCRIPTION	NOTES
None	No programmed event.	
Standby On	Turn Standby mode on.	
Standby Off	Turn Standby mode off.	
Power Off	Turn Power off.	
Channel selection	Select a channel from the Channel List.	* Use the number keys to enter the channel #.
Source selection	Select an input.	* Use the number keys to enter the switcher # and slot #.
ACON (Full)	Perform an ACON (full) auto-convergence.	ACON module is required.
ACON (Touchup)	Perform an ACON (touchup) auto-convergence.	ACON module is required.
ACON (Center Only)	Perform an ACON (center only) auto-convergence.	ACON module is required.
Channels Up	Switch to the next available channel from the Channel List.	Cycles back to the first channel after last channel is selected.
Channels Down	Switch to the prior available channel from the Channel List.	Cycles back to the last channel after the first channel is selected.
Warmup	Perform a warm-up sequence: 1) Turn Standby mode off (if on). 2) Set Contrast to 20%, Brightness to 50%, HSize to 80%, VSize to 80% and master static focus to 100% 3) Display white field for 15 min. 4) Restore original display settings.	Exit from warm-up occurs after 15 minutes or when the EXIT key is pressed. Other keys which stop warm-up are PROJ, *, UTIL, CONV and RECALL. When warm-up stops, all original display settings are restored.

* Only valid entries are accepted.

The Interval Field

The Interval field shows a date or interval at which the event is to take place. With the cursor positioned on the Interval field press **ENTER** to cycle through the available options. See Table 3-2 below for details.

Table 3-2. *Interval Field Options*

EVENT INTERVAL	ACTIVATES THE EVENT . . .	NOTES
specific date	At a specific calendar date.	* Use number keys for date entry per the format defined by the Set Clock utility.
Daily	Every day.	
Mon–Fri	Every Monday through Friday.	
Sat–Sun	Every Saturday and Sunday.	
Mondays	Every Monday.	
Tuesdays	Every Tuesday.	
Wednesdays	Every Wednesday.	
Thursdays	Every Thursday.	
Fridays	Every Friday.	
Saturdays	Every Saturday.	
Sundays	Every Sunday.	
min./sec. interval	Repeatedly at a specified time interval, in minutes and seconds, starting at the time set in the the Start field. (applies to Channel Up/Down events only.)	

* Only valid entries are accepted.

The Start Field



The Start field shows the start time of the event. With the cursor positioned on the Start field use the number keys to enter the start time. Use the notation previously defined by the Set Clock utility (12 hour or 24 hour). If using a 12 hour clock, press **ENTER** to toggle between a.m. and p.m.

Notes: Only valid entries are accepted. For example, if “4” is entered as the first digit of the Start time it will not be accepted. The first digit must be either “0” or “1” when using a 12 hour clock, and “0”, “1” or “2” when using a 24 hour clock.

The Enabled Field

The Enabled field allows you to enable or disable a programmable event. When enabled, the event is performed as programmed. When disabled, the programmed event is ignored. A check mark indicates that the event is enabled. With the cursor positioned on the Enabled field press **ENTER** to toggle display of the check mark.

General Notes about Programmable Events

- 1) All events are ignored if Programmable Events is set to Off in the Preferences menu ( ).
- 2) The projector must be turned on for programmable events to take place.
- 3) Be careful not to schedule two events so close to each other such that the second event is scheduled to begin before the first event is complete; otherwise the second event may be ignored. For example, do not schedule an event to take place one minute after a full ACON auto-convergence. A full ACON convergence takes longer than one minute to complete.
- 4) If the projector is not at operation level when an event is scheduled to begin, that event will be ignored unless operation level is returned within the minute that that event is to take place.
- 5) An error or “invalid” message is temporarily displayed at the bottom of the feature box when an entry is invalid or does not make sense.
- 6) “Error” in an Enabled field indicates an invalid entry for that event.
- 7) Events scheduled at the same time are performed in the order listed in the Programmable Events feature box. Events never occur simultaneously.

About Channel Up/Down Events ...

Channel Up/Down events are handled differently than other events. A Channel Up or Channel Down event is continuously repeated at the time interval set by the Interval field. The process begins at the start time set by the Start field. This feature is provided for applications such as surveillance or status display systems where multiple sources are sharing one projection display. For example, a bus terminal may use this feature to display a number of different bus schedules, each displayed for ten seconds at a time.



To use this feature, a number of video sources must be fed to the projector or a connected switcher. Each source is assigned to a channel in the Channel List. The U/D status of each of these channels must be enabled in the list – see the Channel List entry in this section for details. Within the Programmable Events feature box, the event type is set to Channel Up or Channel Down. The interval and start time is entered and the event is enabled by setting a check mark in the Enabled field. When the event is enabled and the start time is reached, the projector begins cycling through the enabled channels in the Channel List. Each channel-defined source is displayed for the set interval period then the next lower or higher channel enabled in the Channel List is displayed. This continues until the event is disabled or the projector is turned off.

Note: If during Channel Up/Down cycling you press a key to make an adjustment or change a projector setting, the channel cycling process pauses until you return to operation level. If you manually select a different channel, channel cycling will resume from that channel.

3.8 Multi-projector Functions

In a multi-projector installation it is usually desired to have a single IR keypad control all the projectors in the system. This section explains the special control functions available for such installations.

The Projector ►

The Projector function allows you to select which projector in a group will respond to IR keypad commands. To use this function, each projector in the installation must first be assigned a unique projector number. Projector numbers are assigned through the Communication Setup menu which is accessed by pressing **UTIL** **6** **2** on a built-in keypad or a wired remote keypad. Once each projector has its own unique projector number, projectors in the installation can be individually controlled using the same IR keypad.



To select a projector to solely respond to commands from an IR keypad, press **PROJ** followed by the projector's identity number. The specified projector will be the only projector which will respond to the keypad. To enable ALL projectors to listen to the IR keypad, press **PROJ** *****.

Note: One, two, or three digits may be entered for the projector number. Response is immediate if all three digits are entered (i.e., 001). Otherwise, leading zeros are assumed after a five second time-out. **ENTER** can also be used when less than the full three digits are entered. For example, **PROJ** **2** **ENTER** immediately selects projector 002 for control.

Maintenance

4.1 Warnings and Guidelines

The Madrigal Imaging MP-8 and MP-9 projection system is FCC and CSA approved and is designed for safe and reliable operation. However, safe operation cannot simply be assured by design; installers, maintainers, and users must maintain a safe operating environment for the system. This section covers warnings and guidelines which promote the safe usage of the projector. Please read through and understand these warnings and guidelines.

Labels and Markings ➤

Observe and follow all warnings and instructions marked on the projector.

The exclamation point within the equilateral triangle is intended to alert the user to the presence of important operating and maintenance (servicing) instructions in the literature accompanying the projector.



The lightning flash with arrowhead symbol, within the equilateral triangle is intended to alert the user to the presence of uninsulated "dangerous voltage" within the projector's enclosure that may be of sufficient magnitude to constitute a risk of electric shock to persons.



Projector Location ➤

Operate the projector in an environment which meets the operating range specifications in Section 5. Do not operate the projector close to water – for example, near a swimming pool.

Do not place the projector on an unstable cart, stand or table. If the projector is to be ceiling mounted, only use an Madrigal Imaging approved ceiling mount fixture.

The projector and cart combination should be used with care. Quick stops, excessive force, and uneven surfaces may cause the projector and cart combination to overturn.



Power Cord and Attachments ➤

Only use attachments or accessories recommended by Madrigal imaging. Use of others may result in the risk of fire, shock or personal injury.

Do not allow anything to rest on the power cord. Locate the projector where the cord cannot be abused by persons walking on it or objects rolling over it.

Operate the projector at the voltage indicated on the line voltage indicator. Do not overload power outlets and extension cords as this can result in fire or shock hazards.

The projector is equipped with a three wire plug having a third (grounding) pin. **This is a safety feature.** If you are unable to insert the plug into the outlet, contact an electrician to have the outlet replaced. Do not defeat the safety purpose of the grounding-type plug.

Ventilation Slots ➤

Slots and openings in the projector provide ventilation. To ensure reliable operation of the projector and to prevent overheating, these openings must never be blocked or covered. The projector should never be placed near or over a radiator or heat register. The projector should not be placed in an enclosure unless proper ventilation is provided.

Do not push objects of any kind into the projector through the ventilation openings. They may touch dangerous voltages or short-out parts resulting in a fire or shock hazard. Do not spill liquids of any kind into the projector. Should an accidental spill occur, immediately unplug the projector and have it serviced by a qualified service technician.

Servicing ➤

If any of the following conditions exist, unplug the projector from the power outlet and refer service to qualified service personnel.

- The power cord has been damaged.
- Liquid has been spilled into the projector.
- The projector has been exposed to excessive moisture.
- The projector does not operate normally.
- The projector has been dropped or the case has been damaged.
- Projector performance has deteriorated.

Do not attempt to service the projector yourself. All servicing must be performed by a qualified Madrigal Imaging service technician. If replacement parts are required, it is important that only Madrigal Imaging approved parts are used. Other parts may result in fire, electric shock or risk of personal injury.



WARNING: THE PROJECTOR IS INTERNALLY SHIELDED TO PROTECT THE USER FROM EXPOSURE TO SOFT X-RAY RADIATION. IMPROPER SERVICING OR SHIELD REMOVAL MAY RESULT IN PERSONAL INJURY.





- In rare instances, flashing lights can trigger an epileptic seizure. During ACON usage persons with epilepsy should look away from the screen.

4.2 Cleaning

Clean the projector when required. Before cleaning, always unplug the projector from the power outlet.

- **Lens Cleaning** To avoid the risk of scratching the lenses, only clean the lenses if absolutely required. A small amount of dust on the lenses will have very little effect on picture quality. If the lenses must be cleaned, use a DRY soft cotton cloth. Rub gently in a circular motion.

- **Case Cleaning** Clean the case with a soft dampened cloth. Use a mild commercial cleaner. Do not use liquid or aerosol cleaners.

ACON Cleaning



The lens on the ACON Locator Assembly is very tolerant to dust and should only be cleaned if ACON performance is affected. Cleaning of the lens (if required) must be performed with great care. Use a DRY soft cotton cloth. Rub gently in a circular motion.

4.3 Troubleshooting

If the projector is not operating properly, note the symptoms of the problem and use the following guide to assist you. If you cannot resolve the problem yourself, contact your dealer for assistance.

Projector Response Problems

Refer to the following if the projector is not responding to keypad commands.

Symptom: The projector will not turn on when **POWER** is pressed. All back panel lights are off. See Figure 4-1.

Cause/Remedy:

- 1) The power cord may be disconnected. Check the power cord connection at the wall outlet and the projector.

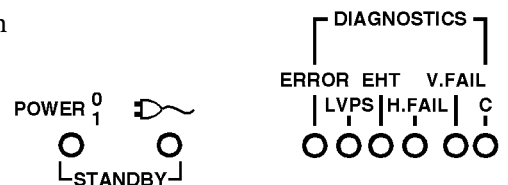

Figure 4-1. Rear Panel LEDs

Symptom: The projector will not turn on when **POWER** is pressed. Only the amber LED on the back panel is lit.

Cause/Remedy:

- 1) **POWER** may not have been held down long enough to initiate projector power-up. Hold down **POWER** for at least one second to initiate power-up.
- 2) If using an IR keypad, ensure it is pointed at the screen or the front of the projector. If the keypad is configured for built-in or wired usage, make sure it is properly connected to the projector.

- 3) If using an IR keypad, the batteries may need replacement. Remove the batteries from the battery compartment on the back side of the keypad. Install new batteries as described in the section 2.3.
- 4) The keypad may be damaged. If the back panel C LED does not flash when **POWER** is pressed, the projector is not responding to the keypad. Try using a different keypad.
- 5) If using a remote keypad (IR or wired), the keypad's protocol (A or B) might not match the projector's IR protocol setting. Refer to section 2.3, *Hardware Setup* for instructions on how to check and change the keypad's protocol setting. However, if the projector's setting is "Off", the remote keypad will not respond. You may have to configure the keypad for built-in operation to gain control of the projector.

Symptom: The projector will not turn on when **POWER** is pressed. One or more of the following red LEDs are lit: *ERROR, LVPS, EHT, H.FAIL, V.FAIL*.

Cause/Remedy: 1) An internal failure has occurred. Projector servicing may be required. Contact your dealer or Madrigal for assistance.

Symptom: The projector's green POWER LED is lit and all other LEDs are off yet no picture is displayed.

Cause/Remedy: 1) Contrast or brightness may be set too low. Press **STATUS** to activate the status screen. If there is no display, press **MENU** then increase contrast (**CONT**) and brightness (**BRITE**) until the crosshatch is displayed. Adjust contrast and brightness to their proper settings.

2) The room lighting may be too bright.

3) The projector may be too far from the screen. Move the projector closer to the screen. The maximum throw distance is 25 feet.

4) Were the lens covers accidentally left on? Remove the lens covers.

Symptom: While in use, the projector suddenly become non-responsive to keypad commands, even when using a built-in keypad.

Cause/Remedy: 1) Although rare, it is possible that an internal software error occurred which has put the software in a non-ending loop. This might occur if a power spike interfered with the projector's internal processor system. To fix this problem, leave the projector plugged in and using a small screw driver or ball point pen, press the recessed RESET button on the back panel. This operation will reset the projector's processor without affecting memories or display settings.

Symptom: The projector does not respond to the **[STBY]** or **[MUTE]** keys.

Cause/Remedy: 1) You may not be holding down the key long enough to initiate the action. Like **[POWER]**, **[STBY]** and **[MUTE]** must be pressed down for at least one second.

Symptom: The projector does not respond to an IR Remote keypad.









Cause/Remedy:

- 1) The projector's IR keypad listening status may be turned off. Press **[PROJ]** **[*]** to turn on the listening status of all projectors, or press **[PROJ]** followed by the projector's identity number to turn on the listening status of the projector you want to respond.
- 2) The keypad's protocol (A or B) might not match the projector's IR protocol setting. Refer to section 2.3, *Hardware Setup* for instructions on how to check and change the keypad's protocol setting. However, if the projector's setting is "Off", the remote keypad will not respond. You may have to configure the keypad for built-in operation to gain control of the projector.
- 3) The IR keypad may be too far away from the projector or screen. Use the IR keypad closer to the projector or screen. Also ensure the keypad is pointed directly at the screen or the front of the projector.
- 4) The viewing path between the IR keypad and the projector (or screen or switcher) may be restricted. Ensure there is a clear line-of-sight between the keypad and the projector (or screen or switcher).
- 5) The sensor may be disabled per the Keypad Options menu (**[UTIL]** **[6]** **[1]**).
- 6) The batteries in the IR keypad may be weak. Replace the batteries in the keypad. See section 2.3 for battery installation instructions.
- 7) There may be unusual lighting conditions in the room which effect IR keypad operation. Determine if such conditions exist and correct.

Symptom: The display is jittery or unstable.

Cause/Remedy:

- 1) The horizontal or vertical scan frequency of the input signal may be out of range. Check the specifications in Section 5 for scan frequency ranges.
- 2) Synchronization signals from the source may be inadequate. Correct the source problem.
- 3) The input signal type may not match the signal type required by the input module. Install the correct input module/interface to match the signal type of the source.

- Symptom:* The upper portion of the display is waving, tearing, or jittering.
- Cause/Remedy:* 1) This sometimes occurs when the source is a VCR or video signal. Change the sync mode by selecting the fast/slow sync option from the Picture Adjust menu ( ).
- Symptom:* The upper or lower portions of the display are cut off.
- Cause/Remedy:* 1) A top or bottom blanking adjustment may be required. Select the appropriate blanking adjustment option from the Picture Adjust Menu () then adjust the amount of blanking. *Note: A 0% sidebar level indicates no blanking.*
- 2) A phase adjustment may be required. Select Position from the Picture Adjust menu (). Adjust position so that the entire picture is visible and centered.
- Symptom:* One side of the display is cut off.
- Cause/Remedy:* 1) A left or right blanking adjustment may be required. Select the appropriate blanking adjustment option from the Picture Adjust menu () then adjust the amount of blanking. A 0% sidebar level indicates no blanking.
- 2) A position adjustment may be required. Select Position from the Picture Adjust menu (). Adjust phase so that the entire picture is visible and centered.
- 3) The retrace time of the projector may be longer than the horizontal blanking time of the signal. Press    to change projector retrace time to Short.
- Symptom:* Transitions between colors are fuzzy.
- Cause/Remedy:* 1) Convergence may require adjustment. Perform a convergence on the selected source.
- 2) The projector may not be optically aligned for the installation. Has the throw distance changed significantly since the last optical alignment? If so, have the projector re-aligned. Refer to section 2.8, *Optical Alignment*.
- Symptom:* The display is very faint.
- Cause/Remedy:* 1) Contrast or brightness settings may be set too low.
- 2) The projection room may be too bright. Lower the intensity of projection room lighting. Reduce light reflections as much as possible.
- 3) The projection room walls and ceilings may be too reflective. Reflective ceilings, walls, and floors should be kept to a minimum. The best projection rooms are dark with matte finishing.

- 4) The projector may be too far from the screen.
- 5) The location of the audience with respect to the screen may not be adequate. Make sure the audience is within the viewing angle set by the projector and screen position, and the screen type.
- 6) The phase setting may require adjustment. Select Position from the Picture Adjust menu () then determine if adjustment improves the display.
- 7) The source may be double terminated. Ensure the source is terminated (75Ω) only once.

Symptom: The display appears to be folded.

Cause/Remedy: 1) The phase setting may require adjustment. Select Position from the Picture Adjust menu () then determine if adjusting the phase improves the display.

Symptom: The display is reversed or upside down.

Cause/Remedy: 1) The projector scan configuration is not set correctly for the installation type. Refer to section 2.3, *Hardware Setup*, to set the projector's scan configuration.

Symptom: The display is not sharp or "clean".

Cause/Remedy:

- 1) Display adjustment may be required. Adjust the brightness, contrast, focus, and detail settings.
- 2) Is a BNC T connector being used? Use a distribution amplifier to boost signal levels.
- 3) Is the input signal properly terminated?
- 4) The screen size may be too large. As screen size increases, magnification increases which reduces brightness. This then reduces the contrast ratio which affects legibility. Sharp defined edges become soft and fuzzy.
- 5) The source input signal may be of low quality.

Symptom: Display quality seems to drift (from good to bad, bad to good, etc.).

Cause/Remedy:

- 1) The operating temperature of the projector may not be constant. Is the projector close to heating and/or air conditioning vents? The ambient temperature after warm-up should be kept constant below 35°C (95°F). Make sure none of the projector ventilation slots are obstructed.
- 2) The source input signal may be of low quality.
- 3) The horizontal or vertical frequency of the input may have changed at the source end. For the selected source, set ASR to on. The projector will then try to use display parameter settings which are best matched for the source.

Symptom: Colors on the display are not accurate (when using the Multi-standard Decoder).

Cause/Remedy: 1) Color and tint settings may require adjustment.

Symptom: The display is not rectangular in shape.

Cause/Remedy: 1) The geometry settings may not be set correctly. Adjust the display geometry settings. (Press **GEOM** for the Geometry menu).

Symptom: The display is “noisy.”



Cause/Remedy:

- 1) The input may not be terminated. Make sure the input is terminated (75Ω). If it is the last connection in a loop-through chain, it should be terminated at the projector (only).
- 2) The signal cables carrying the input signal may be of poor quality. Use only good quality signal cables. Madrigal Imaging cables are recommended.
- 3) The distance between the input source device and the projector may be too great. If the distance between the input source device and the projector is greater than 25 feet, signal amplification/conditioning may be required.
- 4) There may be interference from other equipment. Keep the projector away from devices which radiate electromagnetic energy such as motors and transformers. Common sources of these are slide projectors, speakers, power amplifiers, elevators, etc. Keep 35 mm slide projectors at least two feet away from the projector.
- 5) The input signal may be of poor quality.
- 6) If the source is a VCR or off-air broadcast, detail may be set too high.

Symptom: Modified display settings are not being saved in the active setup memory.

Cause/Remedy:

- 1) Is the active setup memory locked? Press **SOURCE** to display the Source Message. If a  is displayed, unlock the setup. (Press **UTIL** **1** **3**.)
- 2) ASR is set to On for the current input memory and an ASI was automatically performed due to mismatched scan frequencies.

Symptom: The display is OK when displaying the crosshatch test pattern () or status screen () but when trying to display a source, nothing is visible.

Cause/Remedy:

- 1) You may not be selecting the source correctly. Refer to section 3.3, *Source Selection*, for source selection instructions.
- 2) The source may not be connected properly. Verify that the input source is active and check the cables between the source and the projector.

ACON Errors ➤

If ACON is installed and an error message occurs during automatic convergence or Learn Screen, proceed through the following checklist.

- ❑ Is the ambient lighting appropriate for projection? A number of problems could result during automatic convergence and/or Learn Screen if the ambient lighting is too bright. Dimmed incandescent lighting is preferred over fluorescent lighting. If error messages such as "Sensor Lock Failed: Low Signal" or "Learn Screen Failed: Insufficient Magnitude" result, lower the ambient lighting, especially at the projection screen.
- ❑ Is the view path of the Locator Assembly completely unobstructed? The view path between the photosensor lens of the Locator Assembly and the entire screen must be completely unobstructed for proper ACON operation.
- ❑ Has a Learn Screen been performed since the last projector configuration change? Learn Screen must be performed if:
 - The throw distance has changed since the last time Learn Screen was performed.
 - The ACON Locator Assembly mounting position has changed since the last time Learn Screen was performed.
 - The screen type has changed.
 - The source has changed.

If the problem cannot be resolved, call your dealer for servicing.

Specifications

5.1 Specifications *MP-8 and MP-9*

Note: Due to constant research, specifications are subject to change without notice.

- Optics** ➤
 - ❑ High definition hybrid lens
 - ❑ Optical resolution of 10 line pairs per mm
 - ❑ 8" (*MP-8*) and 9" (*MP-9*) electromagnetic focus CRTs
 - ❑ Scheimpflug adjustment for top, bottom, and side-to-side focus
 - ❑ Liquid coupling for optimized contrast ratio (*MP-9* only)

- Resolution** ➤
 - ❑ 2500 x 2000 addressability
 - ❑ 1500 x 1200 ANSI pixels for *MP-9*, 1350 x 1100 for *MP-8*

- Brightness** ➤
 - ❑ Usable light output per industry standard:
160 ANSI lumens for *MP-9*, 200 ANSI lumens for *MP-8*

- Display** ➤
 - ❑ Electronic geometry circuits separately correct top, bottom and sides for flat, curved or rear screens up to 25 feet diagonal
 - ❑ Keystone circuitry to correct pictures for angles greater than $\pm 15^\circ$ vertically from screen axis (dependent on throw distance)
 - ❑ Color temperature adjustment for precise setup
 - ❑ S and C vertical and horizontal linearity
 - ❑ Adjustable top, bottom and side blanking
 - ❑ 9 zone electronic astigmatism correction (service adjustment)

- Input Signals** ➤
 - ❑ RGB Video Input Level: 0.5 to 1.0 volts p-p, $75\ \Omega \pm 1\%$ terminated
 - ❑ Automatically switches to separate sync, composite sync, or sync on green
 - ❑ Separate or composite syncs are automatically accepted in either polarity
 - ❑ 1.0 volts nominal audio input level
 - ❑ Sync on green: max horizontal frequency is 130 kHz
 - ❑ Sync input level: 0.3 to 5.0 volts p-p, $75\ \Omega \pm 1\%$ terminated

- Gamma Correction** ➤ Gamma correction circuitry provided for improved video performance and gray-scale tracking.

- Frequency Response** ➤ 120 MHz bandwidth (-3 dB)
 Accommodates 3 nanosecond pixels and digital clock rates over 300 MHz

- DC Restoration** ➤ Keyed clamp, better than 1%

- Geometry Distortion** ➤ Horizontal: 2.0% maximum
 Vertical: 1.0% maximum

- Deflection Circuits** ➤ Smartlock™ circuitry for quick lock-in and ultra steady images

Vertical Deflection

- Frequency Range: 39.5 Hz to 185 Hz autolock
- Size automatically regulated over frequency range and adjustable from 15% underscan to 15% overscan
- Retrace Time: less than 300 microseconds

Horizontal Deflection

- Frequency Range: 14 kHz to 152 kHz autolock
- Size automatically regulated over frequency range and adjustable by ±15%

Frequency Range (kHz)	Retrace Setting	Typical Deflection Retrace (µs)	* Maximum Hor. Blanking of Projector
14 – 30	Long or Short	5.3	7.5
30 – 45	Long	5.0	5.9
30 – 60	Short	2.8	3.6
60 – 100	Long	2.5	3.1
60 – 70	Short	1.4	1.85
70 – 120	Short	1.4	1.6
120 – 152	Short	1.4	1.5

*With left and right blanking control set to 0.

- Notes:
1. Blanking can be increased with left and right blanking controls
 2. Retrace fixed as Short in ranges 45–60 kHz and 100–152 kHz despite user setting
 3. Defl. retrace time must be less than the max. blanking duration
 4. Horizontal blanking duration of the source must be more than the max. blanking duration of the projector to avoid cutting off the left or right edge of the source image.
 5. Max. Blanking duration of the projector must be compatible with all known sources (at the specific source frequency).
 6. Max. Blanking duration of the projector restricted to 1.5 μ s for operation in the range 120 kHz–152kHz.

High Voltage ➤ 34.9 KV regulated to better than $\pm 1\%$

Power Requirements ➤ 90 VAC to 264 VAC universal input
 Line Frequency: 50 to 60 Hz nominal
 Power: 650 watts maximum
 Power factor corrected

Inputs ➤ Built-in RGBHV interface. Optional interface modules install in interface slot
 Built-in RS-232 for computer control, with loop-thru for connection of multiple projectors
 HDTV compatible with optional interface module

Optional Source Expansion ➤ The Signal Switcher allows use of nine additional input modules. Up to nine switchers can be connected
 Maximum Number of Inputs: 78

Control Features ➤ Multi-language software (user selectable)
 Menu driven interface with on-screen help
 Built-in set up tutorials
 Auto power up after power interruption
 Six built-in test patterns
 Internal frequency generator
 Programmable events and real time clock

Servicing ➤ Modular design for ease of servicing
 Most service adjustments are made using the keypad

Environment ➤ **Maximum Operating Range**

- ❑ Temperature: 0 to 35°C
- ❑ Humidity: 0 to 90% non-condensing
- ❑ Altitude: 0 to 10,000 ft. (0-3,000m.)

Storage

- ❑ Temperature: -30°C to 65°C

Heat Dissipation

- ❑ 2450 BTU/Hr (approximate)

- Mounting** ➤
- ❑ Can be ceiling mounted on its optional ceiling mount or placed on a castered cart for portable applications

- Weight** ➤
- ❑ 176 lbs / 80 kg
 - ❑ 229 lbs / 104 kg (shipping weight)

- Accessories** ➤
Included
- ❑ Convertible multi-use, backlit full function keypad
 - ❑ Line Cord and User's Manual
 - ❑ Tool Kit
 - ❑ ACON® II which automates the convergence process, performing complete convergence in less than 3 minutes

- Options** ➤
& Accessories
- ❑ Various interfaces: RGB Input Module, RGB Loop Thru Module, Composite/S-Video Module, HDTV Input Module and PC Analog Input Module.
 - ❑ Signal Switcher
 - ❑ Adapter cables
 - ❑ Ceiling mount and rear screen equipment
 - ❑ RETRO III large screen projection
 - ❑ Castered cart
 - ❑ Librarian software, Encyclopedia software

Contact your dealer or Madrigal for more information about the above products and accessories. Also refer to Appendix H, Interfaces.

- Regulatory** ➤
Approvals
- ❑ FCC Class A, DHHS and HWC requirements, EN55022 Class B
 - ❑ CSA/UL/EN 60 950
 - ❑ EU Directives 73/23/EEC, 89/336/EEC (CE marked)

- Warranty** ➤
- ❑ One year parts and labor for tube (see inside back cover)
 - ❑ Three years parts and labor for everything else (see inside back cover)

Physical ➤

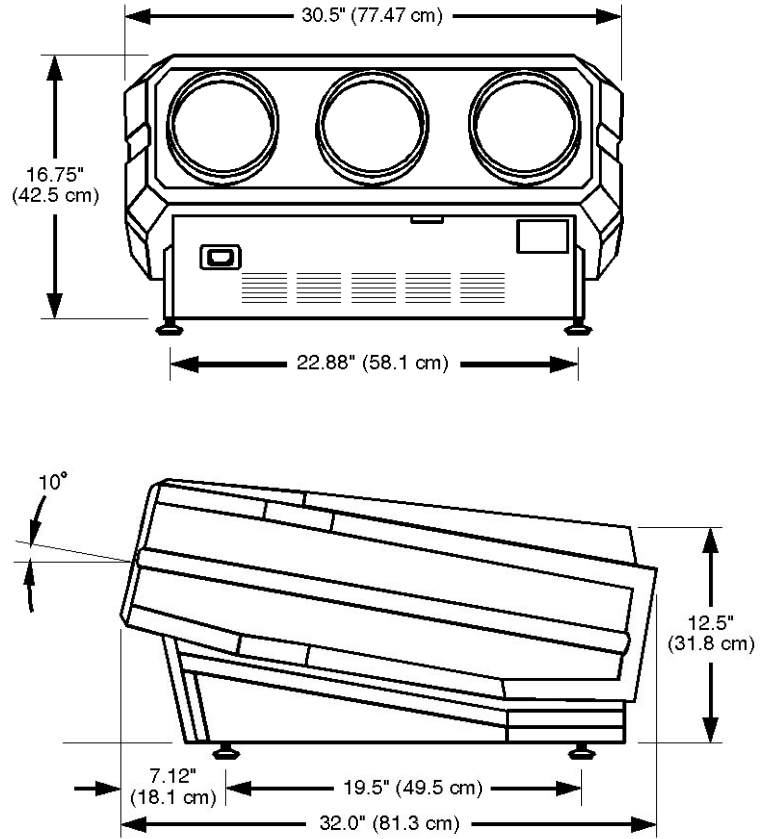

Figure 5-1. *Projector Dimensions*

Appendix A

Glossary

This appendix defines many of the terms used in this manual as they apply to the Madrigal Imaging MP-8 and MP-9 projection system.

- ACON (Automatic Convergence)** ➤ ACON is an automatic convergence feature. Convergence of the red, green and blue images is performed accurately and automatically with minimal user intervention.
- ASI (Automatic Source Interpolation)** ➤ A process whereby a display setup for a given source is approximated from other setups already in memory. For more information about ASI, refer to the ASR entry in section 3.7, *Utility Features*.
- ASR (Automatic Source Recall)** ➤ A process whereby a display setup for a given source is chosen from memory according to its signal parameters (horizontal and vertical frequencies). For more information about ASR, refer to the ASR entry in section 3.7, *Utility Features*.
- Active Line Time** ➤ The time, inside one horizontal scan line, during which video is generated.
- Ambient Light Rejection** ➤ The ability of a screen to reflect ambient light in a direction away from the "line of best viewing". Curved screens usually have good ambient light rejection. Flat screens usually have less ambient light rejection.
- Analog Video** ➤ The video output of most computers and video tape machines. Analog video can generate a large number of colors.
- Aspect Ratio** ➤ The ratio of the width of an image to its height.
- Automatic Convergence** ➤ The automatic alignment of the projected red, green and blue images on the projection screen.

- Autolock** ➤ The ability of the projector to automatically synchronize to the horizontal and vertical scan frequencies of an input signal.
- Bandwidth** ➤ The frequency range of the projector's video amplifier.
- Blanking Time** ➤ The time inside one scan line during which video is not generated. The blanking time of the input signal must be equal to or greater than the retrace time of the projector.
- Bow** ➤ A horizontal curve in the center of the image, and/or a vertical curve across an image.
- Brightness** ➤ Brightness in projection usually describes the amount of light emitted from a surface such as a screen. Brightness is measured in lumens, foot-lamberts, foot-candles, or lux.
- Candela or Candle** ➤ The intensity of light is measured in candelas.
- Channel** ➤ A 2-digit number with user-assigned source input information. This information includes a physical input (switcher, slot), a setup memory (input or recall), and a name or description. Assignments are made through the Channel List.
- Channel List** ➤ A list of up to 99 channels (explained above) which may be created, edited, or deleted by the user. The Channel List feature provides an alternative, and sometimes easier, way to select sources and their setups.
- Color Shift** ➤ The change in the tint of a white field across an image.
- Color Temperature** ➤ This term refers to the coloration (reddish, white, bluish, etc.) of a white image. (It does not refer to the brightness of a white image.) The Kelvin (K) temperature scale is used to measure color temperature.
- Color Temperature Uniformity** ➤ The accuracy of color temperature at any location.
- Composite Video** ➤ This term refers to the output of video tape players and some computers. Synchronization, luminance, and color signals are combined on one output cable.

- Contrast (ratio)** ➤ The ratio of brightness of the brightest possible area to the darkest possible area of an image.
- Convergence** ➤ The alignment of the projected red, green and blue images on the projection screen.
- Current Setup Memory** ➤ The setup memory which is currently being used to display a given source's image.
- Curved Screen** ➤ A projection screen which is curved to improve screen gain. Curved screens usually have screen gains which are greater than 1 but viewing angles much less than 180°.
- Decoder** ➤ A device that converts NTSC, PAL, PAL M, PAL N, PAL 60, SECAM or NTSC 4.43 video to RGB video (Multi-standard Decoder).
- Diffused** ➤ Screen A type of rear-projection screen which spreads the light striking it. Screen gain is less than 1 but audience viewing angles are increased.
- Display Setting** ➤ The level of a display adjustment. Some display adjustments are: Contrast, Brightness, Blanking, Bow, Size, Keystone, Pincushion, Focus and Convergence.
- Flicker** ➤ A rapid variation in brightness created when the frame rate is too slow. (See also Interlace.)
- Frame Rate** ➤ The frequency at which complete images are generated. For non-interlaced signals, the frame rate is identical to the vertical frequency. For interlaced signals, the frame rate is one half of vertical frequency.
- Foot-candle** ➤ The intensity of visible light per square foot.
1 foot-candle = 1 lumen/square foot = 10.76 lux
- Foot-lambert** ➤ The luminance (brightness) which results from one foot-candle of illumination falling on a perfectly diffuse surface.
- Gain or Screen Gain** ➤ The ability of a screen to direct incident light to an audience. A flat matte white wall has a gain of approximately 1. Screens with gain less than 1

attenuate incident light; screens with gain more than 1 direct more incident light to the audience but have a narrow viewing angle. For example: An image reflecting off a 10 gain screen appears 10 times brighter than it would if reflected off a matte white wall. Curved screens usually have larger gain than flat screens.

Gamma Correction ➤

A feature provided on Madrigal Imaging MP-8 and MP-9 models which boosts the blue color output when required to provide improved picture intensity and color uniformity.

Geometry ➤

The reproduction of a straight and rectangular image.

Help Page ➤

A display of help information on the projection screen.

Horizontal Frequency ➤

Also called horizontal scan rate or line rate, this is the frequency at which scan lines are generated. Horizontal frequencies vary amongst sources.

Hot Spot ➤

A circular area of a screen where the image appears brighter than elsewhere on the screen. The hot spot always appears located along the line of sight and "moves" with the line of sight. High gain screens and rear screens designed for slide or movie projection usually have a hot spot.

Input ➤

A physical connection route for a source signal defined by two numbers; a *switcher number* and a *slot number*. If the switcher number is 0, the input is a projector input.

Input Memory ➤

A setup memory which is associated with a particular projector or switcher input.

Interface ➤

A device that accepts an input signal for display by the projector.

Interlace ➤

A method used by video tape players and some computers to double the vertical resolution without increasing the horizontal line rate. If the resulting frame rate is too low, the image may flicker depending on the image content.

Keypad ➤

A device which allows the user to control projector settings and operation. There are four different keypad types which may be used with the projector: built-in, IR remote, wired remote, and presenter's. For more information about these keypads, refer to the keypads entry in section 3.2, *Projector Basics*.

- Keystone** ➤ A distortion of the image which occurs when the top and bottom borders of the image are not equal in length. Side borders slant in or out, producing a keystone shaped image.
- Learn Screen** ➤ An ACON function which stores screen position data in memory for future reference. Learn Screen is usually performed only once per projector installation. If the ACON Locator Assembly or screen is moved (i.e., the projector installation changes to ceiling mount), the Learn Screen function must be repeated.
- Linearity** ➤ The reproduction of the horizontal and vertical size of characters and/or shapes over the entire screen.
- Line of Best Viewing** ➤ When light from a projector is incident on a screen, the light reflects from the screen such that the angle of reflection equals the angle of incidence. The Line of Best Viewing is along the line of reflection.
- Locator Assembly** ➤ The Locator Assembly, situated on the front of the projector, is the "eye" of the ACON system. It includes a photosensor/lens component which mechanically scans the projected display at each convergence point while sensing relative positions of each projected color.
- Loophrough (Loophru)** ➤ The method of feeding a series of high impedance inputs from a single video source with a coaxial transmission line in such a manner that the line is terminated with its characteristic impedance at the last input on the line.
- Lumen** ➤ The amount of visible light emitted by a light source is measured in lumens.
- Lux** ➤ The amount of visible light per square meter incident on a surface.
1 lux = 1 lumen/square meter = 0.093 foot-candles
- Menu** ➤ A list of options which are displayed on the screen for selection by the user.
- NTSC Video** ➤ A video output format of some video tape and disk players. There are two types of NTSC (National Television Standards Committee) video: NTSC 3.58 and NTSC 4.43. NTSC 3.58 is used primarily in North America and Japan. NTSC 4.43 is less commonly used.

- Operation Level** ➤ The projector is at operation level when an image is (or may be) displayed and no control, dialog, error, or help messages are displayed. For example, if a help page is displayed, the projector is not at operation level.
- Optical Screen** ➤ A type of rear-projection screen which re-directs light through the screen to increase image brightness in front of the screen. Screen gain is usually greater than 1 but audience viewing angles are reduced.
- PAL Video** ➤ A video output format of some video tape and disk players (used primarily in Europe, China and some South American and African countries). All PAL (Phase Alternating Line) video is a 50 Hz standard with 768 x 576 resolution.
- Pincushion** ➤ A distortion of the image which occurs when the borders are concave or convex.
- Pixel (Picture Element)** ➤ The smallest discernable element of a computer generated image.
- Projector-to-Screen Distance** ➤ Also called "Throw Distance", the distance between the front of the projector's green lens and the screen.
- Protocol** ➤ The type of code format utilized by IR keypad(s). The standard code is Protocol A. By using two different protocols, two projectors may be used side by side while being controlled independently by their remote IR keypads.
- Rear Screen** ➤ A translucent panel for screen projection. Incident light travels through the incident surface of a rear screen and forms an image on the other surface.
- Recall Memory** ➤ A setup memory which is not associated with any particular input.
- Resolution of the CRT** ➤ The maximum number of lines that can be distinguished on the face of a CRT.
- Resolution of the Lens** ➤ The maximum number of alternate white and black horizontal lines that can be distinguished on a screen when a photographic target is placed between the lens and a light source, and illuminated by that light source.

- Resolution of the Projector** ➤ The smaller of CRT and Lens resolutions.
- Retrace Time (Horizontal)** ➤ The minimum time required for the projector to move the position of the scanning spot from the right edge to the left edge of a CRT.
- Rise Time** ➤ The time required by the video amplifier of the projector to increase its output from 10% to 90% of the maximum value.
- RGB Video** ➤ The video output of most computers. It can be analog or digital. Analog RGB video has 3, 4, or 5 wires; one for red, one for green, one for blue, and none, one or two for sync. For three wire RGB, the green wire usually provides sync. (See also TTL Video).
- Scan Frequency** ➤ The horizontal or vertical frequency at which images are generated.
- Scan Line** ➤ One scan line is one horizontal line on the display.
- SECAM** ➤ A video output format of some video tape and disk players (used primarily in France). SECAM (Sequential Couleur à Mémoire) signals are similar in resolution and frequency to PAL signals. The primary difference between the two standards is in the way color information is encoded.
- Setup Memory** ➤ A projector memory which stores user-adjustable display settings. There are two types of setup memories: *Input* and *Recall*. Both memory types store the same parameters. The only difference is that Input memories store display settings for a particular physical input (i.e., switcher 0, slot 1) and Recall memories can be used with any input.
- Slidebar** ➤ A slidebar is a graphical display of an adjustment setting. The setting is displayed on a percentage scale.
- Source** ➤ A device, such as a computer or VCR, which may be connected to the projector for display.
- Spot Size** ➤ The diameter of the smallest dot that can be generated on the face of a CRT.

- Sync** ➤ This term refers to the part of the video signal that is used to stabilize the picture. Sync can take three forms:
- 1) "Composite sync" when the horizontal and vertical components are together on one cable.
 - 2) "Sync on green" when the sync is part of the green video.
 - 3) "Separate sync" or "H.SYNC and V.SYNC" when the horizontal and vertical components of the sync are on two separate cables.
- Sync Width** ➤ The duration of each sync pulse generated by a computer. The sync width is part of the blanking time.
- TTL Video** ➤ A type of RGB video with digital characteristics.
- Terminated** ➤ A wire connecting a single video source to a display device, such as a projector, must be terminated by a resistance (usually 75Ω for video).
- Throw Distance** ➤ Also called "Projector-to-Screen Distance", the distance between the front of the projector's green lens and the screen.
- Variable Scan** ➤ The ability of a projector to synchronize to inputs with frequencies within a specified range.
- Vertical Frequency** ➤ The frequency at which images are generated. Vertical frequencies vary amongst sources. This term is also called vertical scan rate.
- Video** ➤ The signal that is used by display devices (such as projectors) to generate a picture. This term also refers to the output of video tape/disk players and computers.

- Video Decoder** ➤ A device that converts NTSC, PAL, SECAM or NTSC 4.43 video to RGB video (Multi-standard Decoder).
- Viewing Angle** ➤ Screens do not reflect equally in all directions. Most light is reflected in a conical volume which is centered around the "line of best viewing". Maximum brightness is seen when you are positioned within the viewing cone. The horizontal and vertical viewing angles are the horizontal and vertical angles of the cone.
- White Balance** ➤ White Balance refers to the color temperature of white used by the projector.
- White Field** ➤ A white field is the area of an image that is white only. For example, a full white field is an image that is white everywhere. A 10% white field is a white area (usually rectangular) that occupies 10% of the image; the remaining 90% is black.

MENU TREE

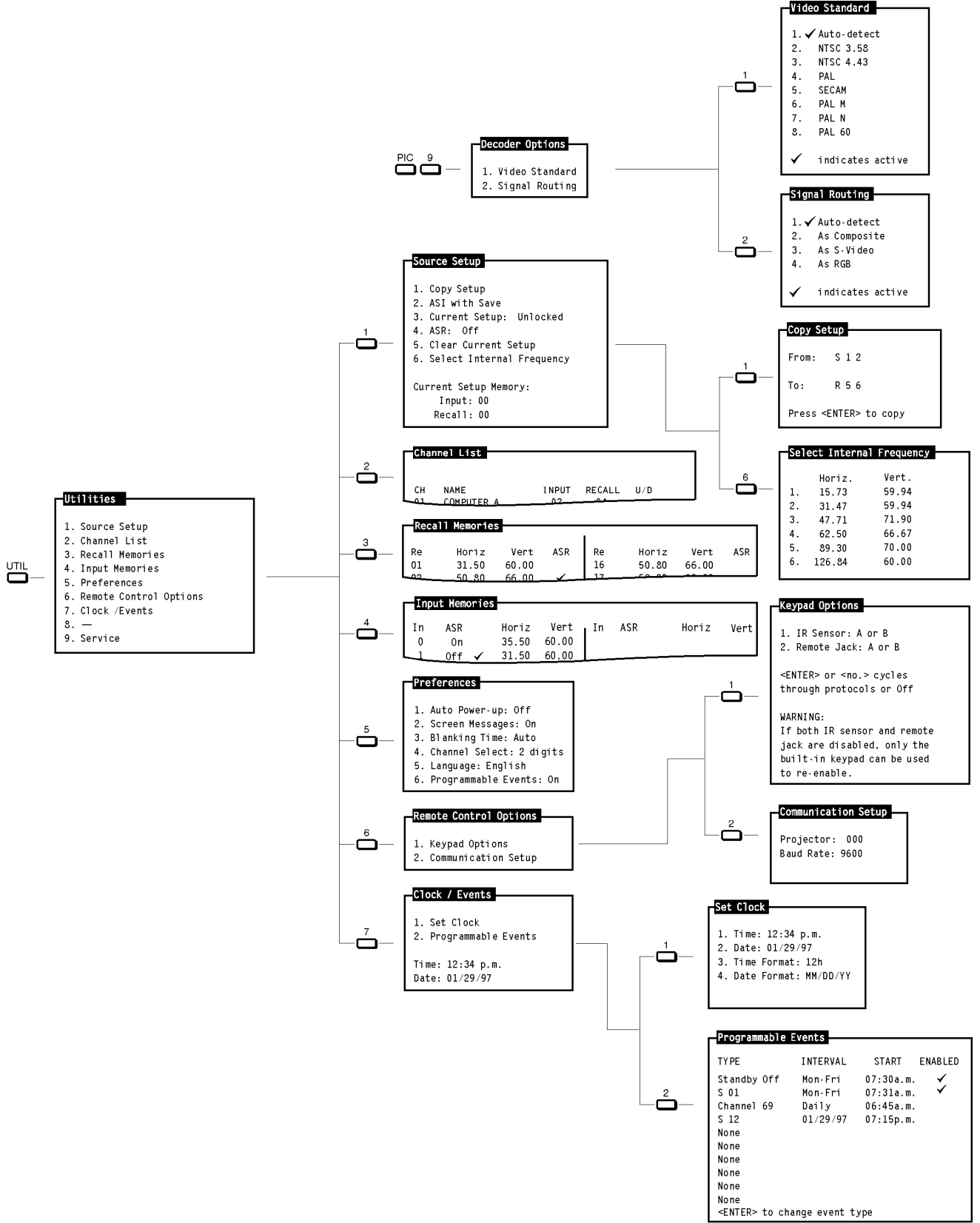

ASR/ASI Logic Diagrams

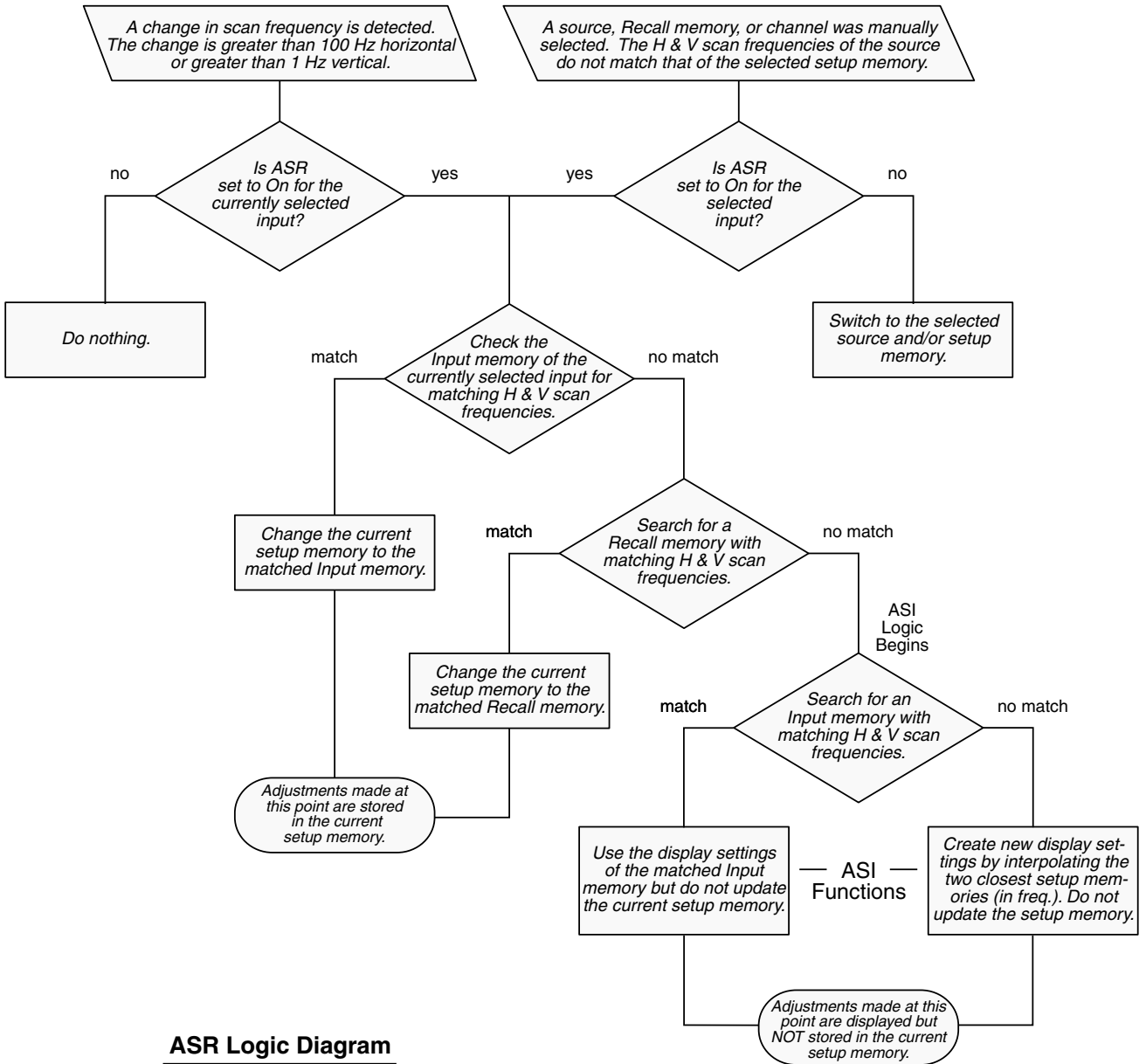

ASR Logic Diagram

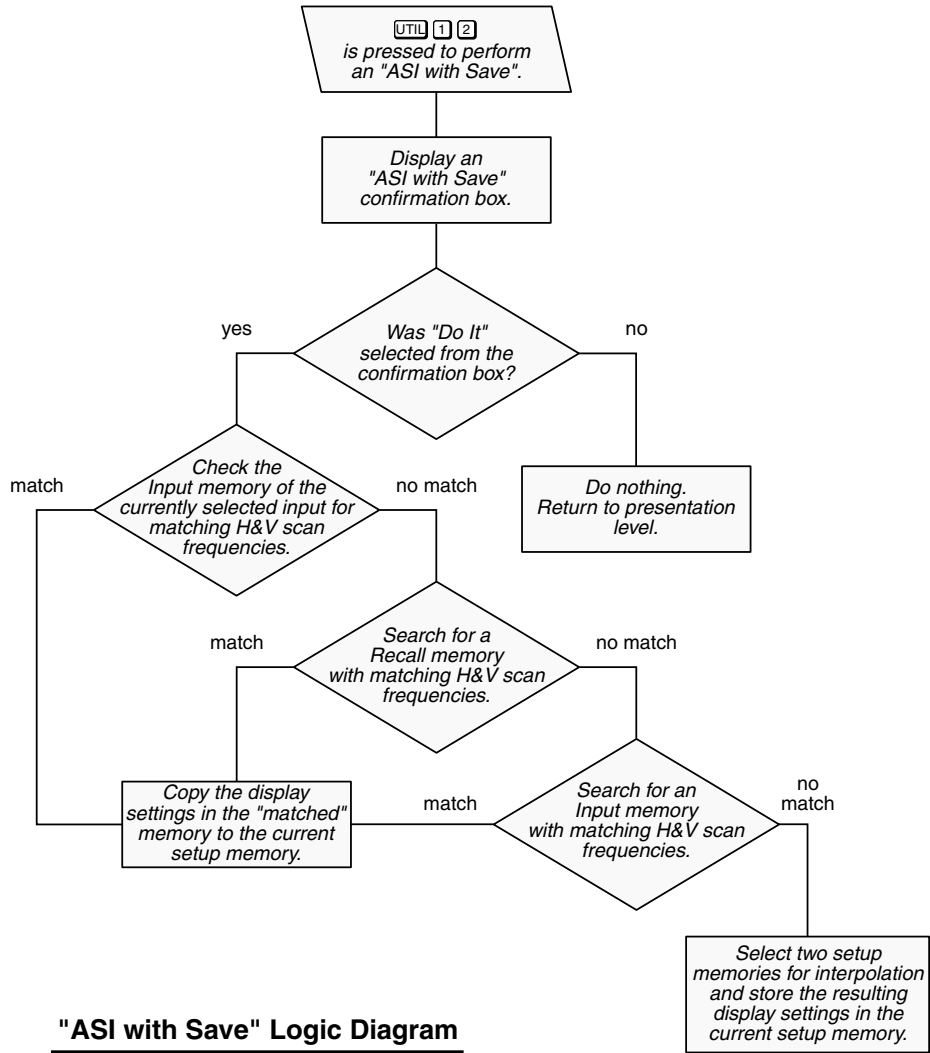

Communication Cables

RS-232 Serial Communications

When connecting the projector to a signal switcher, another Madrigal imaging projector, or a computer, a standard RS-232 serial communication cable is required. Cable details are provided below.

Cable Type: RS-232, 9 Pin Male to 9 Pin Female

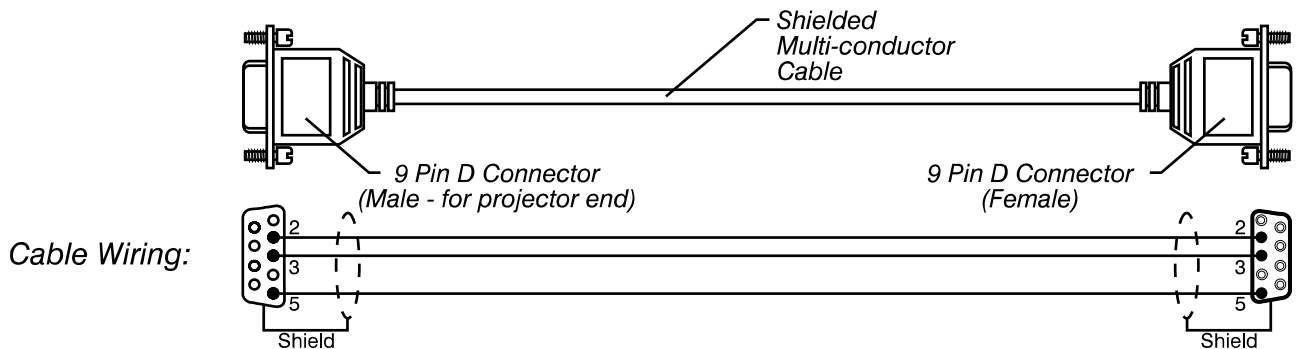

- Application:**
- For connection between the projector and a switcher.
 - For connection between projectors.
 - For connection to a computer with a 9 pin "AT" type RS-232 port.

Cable Type: RS-232, 9 Pin Male to 25 Pin Female

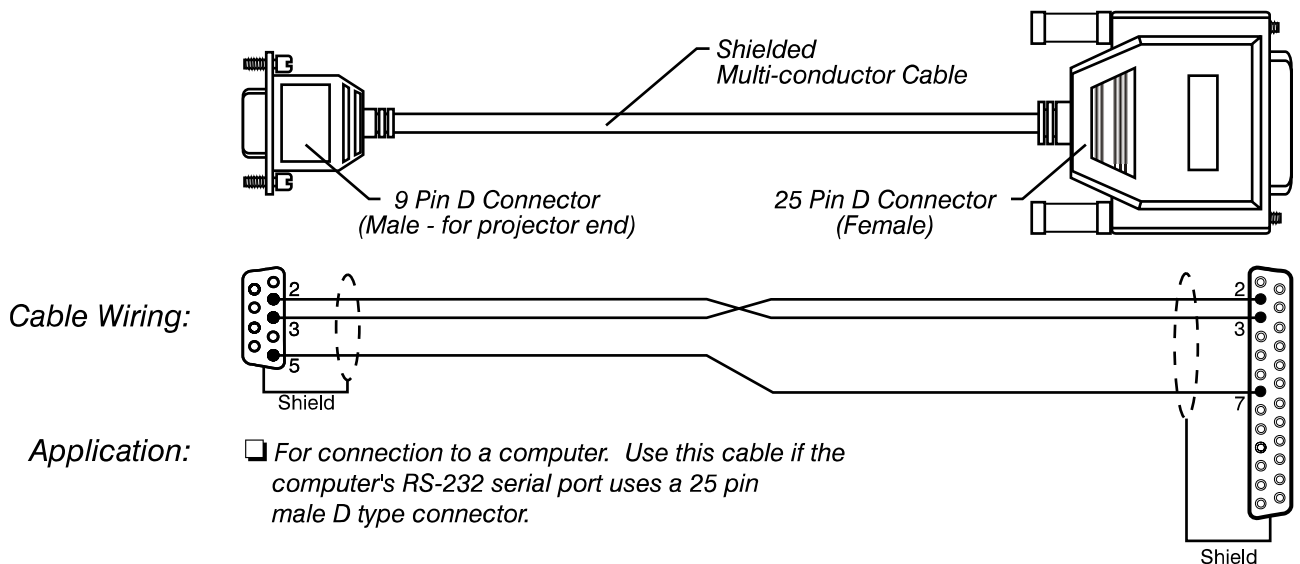

- Application:**
- For connection to a computer. Use this cable if the computer's RS-232 serial port uses a 25 pin male D type connector.

Keypad Reference

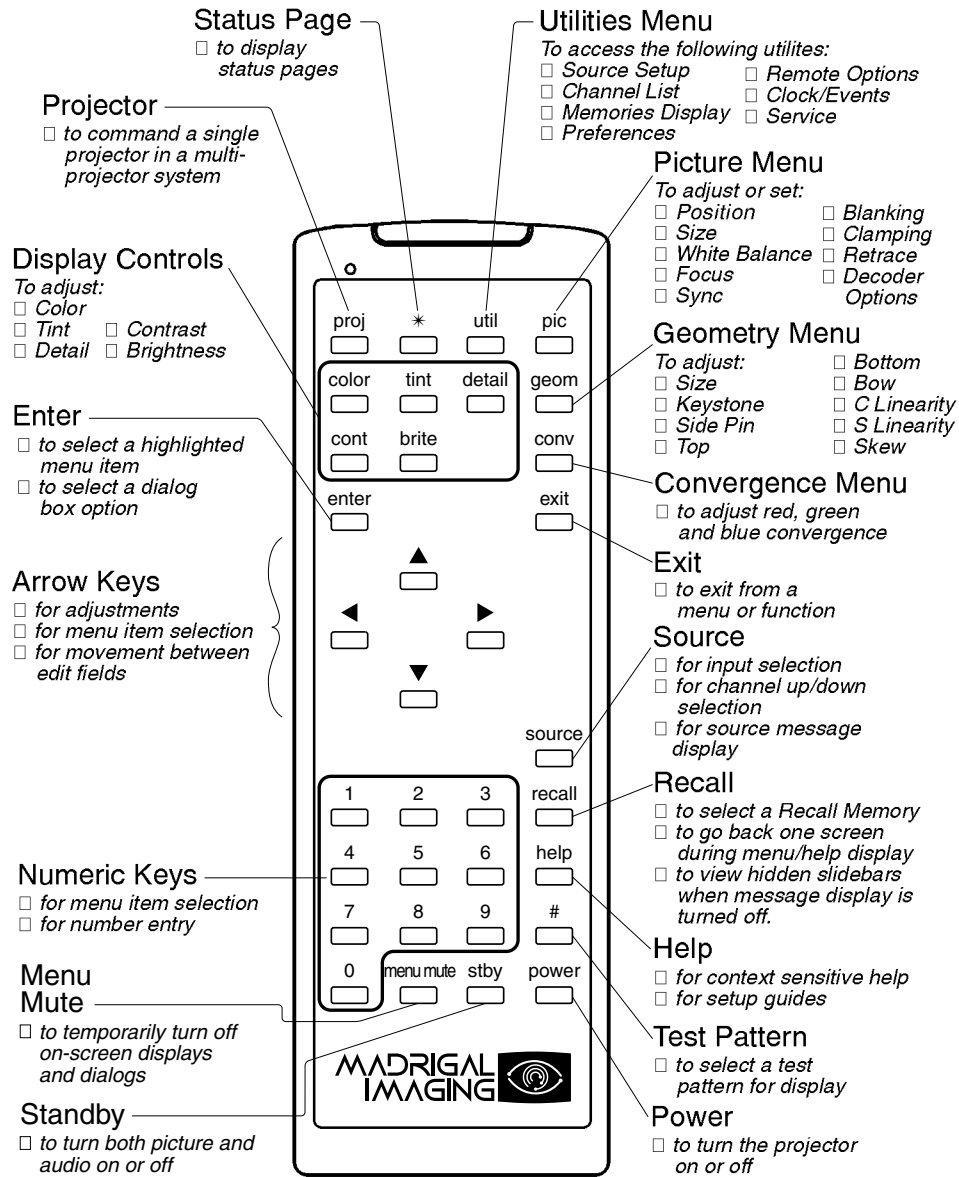

To toggle the keypad's protocol setting (A or B), press BRITE TINT DETAIL 1.

To toggle the keypad's protocol setting (A or B), press BRITE TINT DETAIL 2.

Throw Distance Tables

Table F-1 *Throw Distance for MP-8 (inches)*

screen width	1.33 throw distance	1.78 throw distance	screen width	1.33 throw distance	1.78 throw distance	screen width	1.33 throw distance	1.78 throw distance	screen width	1.33 throw distance	1.78 throw distance
60	78.3	76.2	85	110.4	107.5	97	125.9	122.5	109	141.3	137.6
61	79.5	77.4	86	111.7	108.8	98	127.2	123.8	110	142.6	138.8
62	80.8	78.7	87	113.0	110.0	99	128.5	125.0	111	143.9	140.1
63	82.1	79.9	88	114.3	111.3	100	129.8	126.3	112	145.2	141.3
64	83.4	81.2	89	115.6	112.5	101	131.0	127.6	113	146.5	142.6
65	84.7	82.4	90	116.9	113.8	102	132.3	128.8	114	147.8	143.8
66	86.0	83.7	91	118.2	115.0	103	133.6	130.1	115	149.1	145.1
67	87.3	85.0	92	119.5	116.3	104	134.9	131.3	116	150.4	146.3
68	88.6	86.2	93	120.7	117.5	105	136.2	132.6	117	151.6	147.6
69	89.8	87.5	94	122.0	118.8	106	137.5	133.8	118	152.9	148.9
70	91.1	88.7	95	123.3	120.0	107	138.8	135.1	119	154.2	150.1
71	92.4	90.0	96	124.6	121.3	108	140.1	136.3	120	155.5	151.4
72	93.7	91.2									
73	95.0	92.5									
74	96.3	93.7									
75	97.6	95.0									
76	98.9	96.2									
77	100.1	97.5									
78	101.4	98.7									
79	102.7	100.0									
80	104.0	101.2									
81	105.3	102.5									
82	106.6	103.7									
83	107.9	105.0									
84	109.2	106.3									

Instructions:
Measure the screen width, then find it in the table. The required throw distance is shown.

Notes:

1. All dimensions are in inches. See reverse side for metric table.
2. Throw distance is measured from the projector's center lense to the center of the screen.
3. Use the Size function to adjust image size.
4. These throw distances are mimimums, assuming that you wish to use the maximum available phosphor area. Used correctly, they will deliver the best possible picture. They will, however, require careful attention to proper setup, as there is little room for error at these distances. We recommend leaving yourself $\pm 1/2"$ (± 1.25 cm) adjustment leeway in the mounting system for final fine tuning of placement.
5. Throw distance values are for an MP-8 projector with standard HD-8 lenses. For other lens types, contact your dealer for applicable throw distance formulas.

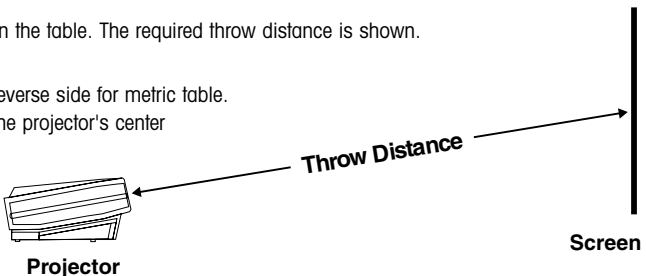

Projector **Screen**

THROW DISTANCE TABLES

Table F-1 *Throw Distance for MP-8 (cm)*

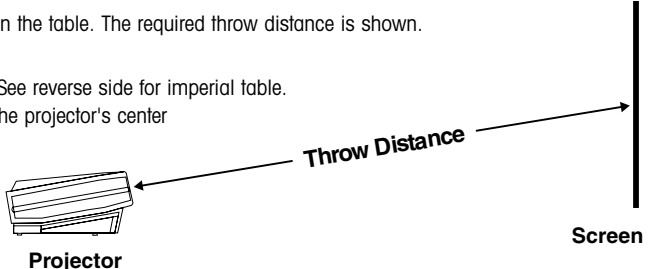
screen width	1.33 throw distance	1.78 throw distance	screen width	1.33 throw distance	1.78 throw distance	screen width	1.33 throw distance	1.78 throw distance	screen width	1.33 throw distance	1.78 throw distance
150	194.1	189.0	206	266.2	259.1	238	307.4	299.2	270	348.6	339.3
152	196.7	191.5	208	268.8	261.6	240	310.0	301.7	272	351.2	341.8
154	199.3	194.0	210	271.4	264.1	242	312.6	304.2	274	353.8	344.3
156	201.9	196.5	212	274.0	266.6	244	315.2	306.7	276	356.4	346.8
158	204.4	199.0	214	276.5	269.1	246	317.7	309.2	278	358.9	349.3
160	207.0	201.5	216	279.1	271.6	248	320.3	311.7	280	361.5	351.8
162	209.6	204.0	218	281.7	274.2	250	322.9	314.3	282	364.1	354.3
164	212.2	206.5	220	284.3	276.7	252	325.5	316.8	284	366.7	356.9
166	214.7	209.0	222	286.8	279.2	254	328.0	319.3	286	369.2	359.4
168	217.3	211.5	224	289.4	281.7	256	330.6	321.8	288	371.8	361.9
170	219.9	214.0	226	292.0	284.2	258	333.2	324.3	290	374.4	364.4
172	222.5	216.5	228	294.6	286.7	260	335.8	326.8	292	377.0	366.9
174	225.0	219.0	230	297.1	289.2	262	338.3	329.3	294	379.5	369.4
176	227.6	221.5	232	299.7	291.7	264	340.9	331.8	296	382.1	371.9
178	230.2	224.0	234	302.3	294.2	266	343.5	334.3	298	384.7	374.4
180	232.8	226.5	236	304.9	296.7	268	346.1	336.8	300	387.3	376.9
182	235.3	229.0	<p>Instructions: Measure the screen width, then find it in the table. The required throw distance is shown.</p> <p>Notes:</p> <ol style="list-style-type: none"> 1. All dimensions are in centimeters. See reverse side for imperial table. 2. Throw distance is measured from the projector's center lense to the center of the screen. 3. Use the Size function to adjust image size. 4. These throw distances are mimimums, assuming that you wish to use the maximum available phosphor area. Used correctly, they will deliver the best possible picture. They will, however, require careful attention to proper setup, as there is little room for error at these distances. We recommend leaving yourself $\pm 1/2"$ (± 1.25 cm) adjustment leeway in the mounting system for final fine tuning of placement. 5. Throw distance values are for an MP-8 projector with standard HD-8 lenses. For other lens types, contact your dealer for applicable throw distance formulas. 								
184	237.9	231.6									
186	240.5	234.1									
188	243.1	236.6									
190	245.6	239.1									
192	248.2	241.6									
194	250.8	244.1									
196	253.4	246.6									
198	255.9	249.1									
200	258.5	251.6									
202	261.1	254.1									
204	263.7	256.6									

THROW DISTANCE TABLES

Table F-1 *Throw Distance for MP-9 (cm)*

screen width	1.33 throw distance	1.78 throw distance	screen width	1.33 throw distance	1.78 throw distance	screen width	1.33 throw distance	1.78 throw distance	screen width	1.33 throw distance	1.78 throw distance
150	192.9	187.8	206	264.9	257.9	238	306.1	298.0	270	347.2	338.0
152	195.5	190.3	208	267.5	260.4	240	308.6	300.5	272	349.8	340.5
154	198.0	192.8	210	270.1	262.9	242	311.2	303.0	274	352.4	343.0
156	200.6	195.3	212	272.6	265.4	244	313.8	305.5	276	354.9	345.6
158	203.2	197.8	214	275.2	267.9	246	316.4	308.0	278	357.5	348.1
160	205.8	200.3	216	277.8	270.4	248	318.9	310.5	280	360.1	350.6
162	208.3	202.8	218	280.3	272.9	250	321.5	313.0	282	362.7	353.1
164	210.9	205.3	220	282.9	275.4	252	324.1	315.5	284	365.2	355.6
166	213.5	207.8	222	285.5	277.9	254	326.6	318.0	286	367.8	358.1
168	216.0	210.3	224	288.1	280.4	256	329.2	320.5	288	370.4	360.6
170	218.6	212.8	226	290.6	283.0	258	331.8	323.0	290	372.9	363.1
172	221.2	215.3	228	293.2	285.5	260	334.4	325.5	292	375.5	365.6
174	223.8	217.8	230	295.8	288.0	262	336.9	328.0	294	378.1	368.1
176	226.3	220.4	232	298.4	290.5	264	339.5	330.5	296	380.7	370.6
178	228.9	222.9	234	300.9	293.0	266	342.1	333.0	298	383.2	373.1
180	231.5	225.4	236	303.5	295.5	268	344.6	335.5	300	385.8	375.6
182	234.1	227.9									
184	236.6	230.4									
186	239.2	232.9									
188	241.8	235.4									
190	244.3	237.9									
192	246.9	240.4									
194	249.5	242.9									
196	252.1	245.4									
198	254.6	247.9									
200	257.2	250.4									
202	259.8	252.9									
204	262.3	255.4									

Instructions:
Measure the screen width, then find it in the table. The required throw distance is shown.

Notes:

1. All dimensions are in centimeters. See reverse side for imperial table.
2. Throw distance is measured from the projector's center lense to the center of the screen.
3. Use the Size function to adjust image size.
4. These throw distances are mimimums, assuming that you wish to use the maximum available phosphor area. Used correctly, they will deliver the best possible picture. They will, however, require careful attention to proper setup, as there is little room for error at these distances. We recommend leaving yourself $\pm 1/2"$ (± 1.25 cm) adjustment leeway in the mounting system for final fine tuning of placement.
5. Throw distance values are for an MP-9 projector with standard HD-10GT17 lenses. For other lens types, contact your dealer for applicable throw distance formulas.

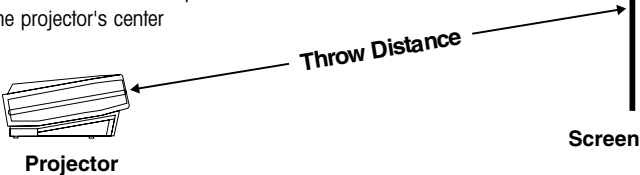





Projector **Screen**

Appendix G

Lenses

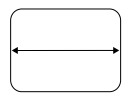
This appendix describes the relationship between lens type, screen size and throw distance as they apply to the projector. Please contact your dealer or Madrigal Imaging for additional assistance.

PROJECTOR 	LENS 	SCREEN WIDTH RANGE 		THROW DISTANCE RANGE 			THROW DISTANCE FORMULA 1.33 SCREEN	THROW DISTANCE FORMULA 1.78 SCREEN
		From	To	From	To	Factory		
Series	Type							
MP-8	HD-8	60"	120"	76.2"	155.5"	84"	$1.2875 \times W + 1$	$1.253 \times W + 1$
MP-9	HD-10GT17	60"	120"	77.2"	154.3"	84"	$1.286 \times W$	$1.252 \times W$

- Notes:
- 1) "Factory" refers to the throw distance used at the factory for optical setup and testing.
 - 2) All diagonal screen sizes are based on a 4:3 aspect ratio. "W" in the throw distance formula represents horizontal screen width. All dimensions are in inches.
 - 3) Calculated values are for reference only. It is good practice to simulate the setup to determine the necessary throw distance.

A

- ACON
 - definition, A.1
 - setup, 2.35
- ASI, 3.35
 - definition, A.1
 - logic diagram C.1
 - set up for, 2.31
- ASI with Save 3.35
 - logic diagram C.2
- Aspect Ratio
 - definition, A.1
 - of screens, 2.5
- ASR, 3.35
 - definition, A.1
 - logic diagram, C.1
 - set up for, 2.32
 - turning on/off, 3.36
- Audio
 - connections, 2.16
 - mute function, 3.9
 - volume function, 3.9
- Auto Power-up 3.43
- Automatic Convergence, 3.21
 - definition, A.1

B

- Baud Rate
 - setting of, 3.46
- Blanking Functions, 3.20
- Blanking Time, 3.43
- Bow, 3.25
 - definition, A.2
- Brightness, 3.17
 - definition, A.2
- Built-in Keypad, 3.2

C

- Ceiling Mount, 2.12
- Channel Cycling, 3.50
- Channel List, 3.40
 - definition, A.2
 - programming channels, 3.40
 - the use of, 3.12
- Channel Selection, 3.12
- Clamping, 3.20
- Clock
 - setting the, 3.46
- Clock/Events, 3.46
- Color, 3.18
- Color Temperature, 3.19
 - definition, A.2

- Communication Cables, D.1
- Contrast, 3.17
 - definition, A.3
- Convergence
 - ACON, 3.31
 - definition, A.3
 - guided, 3.28
 - interpolated, 3.29
 - on image, 3.28
 - random access, 3.30
 - reset, 3.28
 - types of, 3.27
- Copy Setup, 3.35
- Cover Removal, 3.2

D

- Decoder
 - definition, A.3
 - described, H.1
 - selecting options, 3.21
 - signal route selection, 3.22
 - use of, 2.15
 - video standard, 3.21
- Detail, 3.18
- Dialog Boxes, 3.5
- Diffused Screens, 2.14
- Display Adjustments, 3.16
 - convergence, 3.27
 - geometry, 3.24
 - picture, 3.19
 - primary, 3.17
- Display Settings
 - list of, 3.19, 3.10

E

- Error Messages
 - ACON, 3.32
- Expandability, 1.2

F

- Fast/Slow sync, 3.20
- Focus
 - electrical, 3.20
 - optical, 2.17

G

- Geometry Functions, 3.24
- Glossary, A-1
- Guided Convergence, 3.28
- Guided Setup
 - mechanical, 2.17
 - source, 2.26

- Guidelines
 - for projector use, 4.1

H

- Help, 3.6
 - context help, 3.6
 - guided, 3.7

I

- Input Memories, 3.15
 - listing of, 3.42
- Input parameters
 - display of, 3.9, 3.10
- Installation, 2.1
 - considerations, 2.2
 - types, 2.2
- Interfaces
 - built-in RGB, 2.15
 - optional, 2.15, H.1
- Internal Frequencies, 3.39
- Interpolated Convergence, 3.29
- IR Sensor, 3.44

K

- Keypad
 - Backlit control, 2.11
 - battery installation, 2.10
 - controls, 3.3
 - conversion, 2.8
 - guide, 3.7
 - illustration, 3.3, E.1
 - jumper wires, 2.9
 - operating settings, 2.10, 3.44
 - protocol, 2.8, 2.11
 - types, 3.1
 - usage, 3.4
- Keystone, 3.24
 - definition, A.5

L

- Learn Screen
 - definition, A.5
- Learn Screen (ACON), 3.33
- Leg Adjustment, 2.12
- Lighting, 2.6
- Linearity, 3.26
 - definition, A.5
- Locator Assembly, A.5
- Locked Setup Memories, 3.16
 - how to lock/unlock, 3.36

Index

- M**
 - Mechanical Setup
 - guided tutorial, 3.7
 - Memory
 - set up of, 2.29
 - Menu Tree, B-1
 - Menus, 3.5
 - Message Boxes, 3.6
 - Mirror
 - the use of, 2.14
 - Mounting
 - front screen, 2.12
 - rear screen, 2.13
 - Multi-projector Functions, 3.51
 - Multi-standard Decoder
 - described, H.1
 - Mute, 3.9
 - O**
 - Operating Settings
 - display of, 3.9, 3.10
 - Optical alignment, 2.17
 - Optical Screens, 2.13
 - Optical Setup
 - guided, 3.7
 - P**
 - Pincushion, 3.25
 - definition, A.6
 - Position, 3.19
 - Power
 - connection of, 2.15
 - requirements, 2.15
 - turning on/off, 3.18
 - Preferences, 3.43
 - Presentation Level, 3.4
 - Programmable Events, 3.44, 3.47
 - Projection Room
 - lighting, 2.6
 - reflections, 2.6
 - windows, 2.6
 - Projector
 - construction, 1.2
 - cover removal, 3.2
 - description, 1.1
 - identification number, 3.45
 - mounting, 2.12
 - position, 2.6, 2.7
 - selection of, 3.51
 - upgrading, 1.2
 - usage guidelines, 4.1
 - Protocol
 - changing keypad, 2.8
 - definition, A.6
 - Q**
 - Quick Setup
 - instructions, 2.1
 - R**
 - Random Access Convergence, 3.30
 - Recall Memories, 3.15
 - definition, A.6
 - listing of, 3.41, 3.42
 - Regulatory Approvals, 5.4
 - Remote Control
 - preference options, 3.44
 - Remote Jack, 3.45
 - Retrace Time, 3.21
 - Reverse Scan
 - setup, 2.11
 - RGB Interface, 2.15
 - S**
 - Screen
 - aspect ratio, 2.5
 - diffused, 2.14
 - gain, A.3
 - optical, 2.13, A.6
 - size, 2.15
 - types, 2.3
 - Screen Messages, 3.43
 - Serial Port
 - cables, D.1
 - connections, 2.16
 - Service
 - locations, 1.2
 - manuals, 1.2
 - when to, 4.2
 - Setup
 - ASI, 2.31
 - guided, 3.7
 - of Input memories, 2.30
 - of Recall memories, 2.31
 - quick, 2.1
 - using internal frequencies, 3.39
 - Setup Memories, 3.14
 - allocation of, 3.16
 - clearing, 3.39
 - locking, 3.16, 3.36
 - number of, 3.16
 - types of, 3.15
 - Setup Memory
 - definition, A.7
 - Size Function, 3.19, 3.24
 - Skew, 3.26
 - Sliderbar
 - definition, A.7
 - described, 3.5
 - Source
 - connections, 2.15
 - definition, A.7
 - message, 3.13
 - selection, 3.10
 - selection guide, 3.7
 - selection of, 3.10, 3.13
 - setup menu, 3.35
 - Source Setup
 - guided tutorial, 3.7
 - Specifications, 5.1
 - Standby Mode, 3.8
 - Status Pages, 3.9, 3.10
 - Switcher
 - connection of, 2.15
 - described, H.1
 - using ASR with, 2.34
- T**
 - Test Patterns
 - how to display, 3.6
 - Throw Distance
 - calculating, 2.5
 - definition, A.8
 - tables, F.1
 - Tint, 3.18
 - Trouble-shooting, 4.3
 - Tutorials, 3.7
- U**
 - Utility Features, 3.34
- V**
 - Volume, 3.9
- W**
 - Warm Up Time, 3.8
 - Warnings, 4.1
 - Warranty, 5.4
 - White Balance, 3.19

90-DAY LIMITED WARRANTY

Valid in the United States and Canada only

This MADRIGAL IMAGING® product is warranted to be free from defects in material and workmanship under normal use for a period of ninety (90) days from the date of purchase. To extend the warranty of this MADRIGAL IMAGING product, return the warranty registration card along with a copy of the original receipt of purchase to Madrigal Audio Laboratories, Inc., P. O. Box 781, Middletown, CT 06457.

The extended warranty for this MADRIGAL IMAGING product is one (1) year for the tubes, and three (3) years for everything else, from the date of purchase. During the warranty period, any MADRIGAL IMAGING component exhibiting defects in materials and/or workmanship will be repaired or replaced, at our option, without charge for either parts or labor. The warranty will not apply to any MADRIGAL IMAGING component that has been misused, abused or altered.

Any MADRIGAL IMAGING subassembly not performing satisfactorily may be returned to the factory for evaluation. Return authorization must first be obtained by either calling or writing the factory prior to shipping the subassembly. The factory will pay for return shipping charges only in the event that the subassembly is found to be defective as above mentioned. There are other stipulations that may apply to shipping charges.

There is no other express warranty on this component. Neither this warranty nor any other warranty, express or implied, including any implied warranties of merchantability or fitness, shall extend beyond the warranty period. No responsibility is assumed for any incidental or consequential damages. Some states do not allow limitations on how long an implied warranty lasts and other states do not allow the exclusion or limitation of incidental or consequential damages, so that the above limitation or exclusion may not apply to you.

This warranty gives you specific legal rights, and you may also have other rights which vary from state to state. This warranty is applicable in the United States and Canada only. Outside of the U.S. and Canada, please contact your local, authorized Madrigal Imaging distributor for warranty and service information.

Service...

We take great pride in our dealers. Experience, dedication, and integrity make these professionals ideally suited to assist with our customers' needs.

Madrigal's Technical Services Department is set up to solve technical problems efficiently. Its philosophy is based on the knowledge that you've made a substantial investment in audio/video equipment of exceptional quality. It is the intent of the Technical Services Department to provide service to match that investment.

If your MADRIGAL IMAGING component requires service, contact your dealer for assistance. Alternatively, you may contact Madrigal directly, and we will work with your dealer.

It is extremely important that information about a problem be explicit and complete, and include the serial number of the unit. This helps us locate and repair a defect as quickly as possible.

A copy of the original bill of sale must be included to verify warranty status.

In the extremely unlikely case that a circuit module or unit must be returned to Madrigal, the unit must be properly packaged (in its original packing material), and the proper return authorization number must be marked on the outer carton for easy identification. Improper packaging may lead to unnecessary freight damage which will not be covered by the freight carrier. If the packaging in which we receive a unit is, in our opinion, inadequate to protect the unit, we reserve the right to repackage it for return shipment at the owner's expense.

MADRIGAL AUDIO LABORATORIES, INC.
2081 South Main Street / P.O. Box 781
Middletown, Connecticut 06457-0781 USA
(860) 346-0896 FAX (860) 346-6251
<http://www.madrigal.com>



MADRIGAL

Madrigal Audio Laboratories, Inc.
2081 South Main Street, P.O. Box 781
Middletown, Connecticut 06457 USA

Telephone: (860) 346-0896
Fax: (860) 346-1540
<http://www.madrigal.com>

MADRIGAL  **IMAGING**

is a registered trademark of Madrigal Audio Laboratories, Inc.
H a Harman International company